

Medical cold light cable glued (suitable for Halogen light sources)

Ø 3,5 mm

length	grey	blue	green	orange	red	yellow
1800 mm	01.3518.01	01.3518.01B	01.3518.01G	01.3518.01O	01.3518.01R	01.3518.01Y
2300 mm	01.3523.01	01.3523.01B	01.3523.01G	01.3523.01O	01.3523.01R	01.3523.01Y
2500 mm	01.3525.01	01.3525.01B	01.3525.01G	01.3525.01O	01.3525.01R	01.3525.01Y
3000 mm	01.3530.01	01.3530.01B	01.3530.01G	01.3530.01O	01.3530.01R	01.3530.01Y
3500 mm	01.3535.01	01.3535.01B	01.3535.01G	01.3535.01O	01.3535.01R	01.3535.01Y
5000 mm	01.3550.01	01.3550.01B	01.3550.01G	01.3550.01O	01.3550.01R	01.3550.01Y







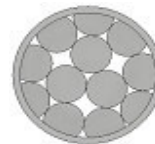

Ø 4,8 mm

length	grey	blue	green	orange	red	yellow
1800 mm	01.4818.01	01.4818.01B	01.4818.01G	01.4818.01O	01.4818.01R	01.4818.01Y
2300 mm	01.4823.01	01.4823.01B	01.4823.01G	01.4823.01O	01.4823.01R	01.4823.01Y
2500 mm	01.4825.01	01.4825.01B	01.4825.01G	01.4825.01O	01.4825.01R	01.4825.01Y
3000 mm	01.4830.01	01.4830.01B	01.4830.01G	01.4830.01O	01.4830.01R	01.4830.01Y
3500 mm	01.4835.01	01.4835.01B	01.4835.01G	01.4835.01O	01.4835.01R	01.4835.01Y
5000 mm	01.4850.01	01.4850.01B	01.4850.01G	01.4850.01O	01.4850.01R	01.4850.01Y



Fiber structure



Light source			Instrument side	
Storz	 KLA-L-101		Storz	 KLA-I-201
ACMI	 KLA-L-102		ACMI	 KLA-I-202
WOLF	 KLA-L-103		WOLF	 KLA-I-203
OLYMPUS	 KLA-L-104		OLYMPUS	 KLA-I-204

(Different colours and lengths of cold light cables and different adapters are available upon request)

Medical cold light cable with glas rod adapter

(for Xenon light sources up to 500°C)

Ø 3,5 mm

length	grey	blue	green	orange	red	yellow
1800 mm	02.3518.01	02.3518.01B	02.3518.01G	02.3518.01O	02.3518.01R	02.3518.01Y
2300 mm	02.3523.01	02.3523.01B	02.3523.01G	02.3523.01O	02.3523.01R	02.3523.01Y
2500 mm	02.3525.01	02.3525.01B	02.3525.01G	02.3525.01O	02.3525.01R	02.3525.01Y
3000 mm	02.3530.01	02.3530.01B	02.3530.01G	02.3530.01O	02.3530.01R	02.3530.01Y
3500 mm	02.3535.01	02.3535.01B	02.3535.01G	02.3535.01O	02.3535.01R	02.3535.01Y
5000 mm	02.3550.01	02.3550.01B	02.3550.01G	02.3550.01O	02.3550.01R	02.3550.01Y

Ø 4,8 mm

length	grey	blue	green	orange	red	yellow
1800 mm	02.4818.01	02.4818.01B	02.4818.01G	02.4818.01O	02.4818.01R	02.4818.01Y
2300 mm	02.4823.01	02.4823.01B	02.4823.01G	02.4823.01O	02.4823.01R	02.4823.01Y
2500 mm	02.4825.01	02.4825.01B	02.4825.01G	02.4825.01O	02.4825.01R	02.4825.01Y
3000 mm	02.4830.01	02.4830.01B	02.4830.01G	02.4830.01O	02.4830.01R	02.4830.01Y
3500 mm	02.4835.01	02.4835.01B	02.4835.01G	02.4835.01O	02.4835.01R	02.4835.01Y
5000 mm	02.4850.01	02.4850.01B	02.4850.01G	02.4850.01O	02.4850.01R	02.4850.01Y



Fiber structure

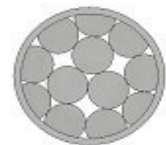





Light source with glas rod adapter

Storz		KLA-LG-101
ACMI		KLA-LG-102
WOLF		KLA-LG-103
OLYMPUS		KLA-LG-104



Instrument side

Storz		KLA-I-201
ACMI		KLA-I-202
WOLF		KLA-I-203
OLYMPUS		KLA-I-204

(Different colours and lengths of cold light cables and different adapters are available upon request)

Medical cold light cable fused

(for Xenon light sources up to 500°C)

Ø 3,5 mm

length	grey	blue	green	orange	red	yellow
1800 mm	03.3518.01	03.3518.01B	03.3518.01G	03.3518.01O	03.3518.01R	03.3518.01Y
2300 mm	03.3523.01	03.3523.01B	03.3523.01G	03.3523.01O	03.3523.01R	03.3523.01Y
2500 mm	03.3525.01	03.3525.01B	03.3525.01G	03.3525.01O	03.3525.01R	03.3525.01Y
3000 mm	03.3530.01	03.3530.01B	03.3530.01G	03.3530.01O	03.3530.01R	03.3530.01Y
3500 mm	03.3535.01	03.3535.01B	03.3535.01G	03.3535.01O	03.3535.01R	03.3535.01Y
5000 mm	03.3550.01	03.3550.01B	03.3550.01G	03.3550.01O	03.3550.01R	03.3550.01Y

Ø 4,8 mm



length	grey	blue	green	orange	red	yellow
1800 mm	03.4818.01	03.4818.01B	03.4818.01G	03.4818.01O	03.4818.01R	03.4818.01Y
2300 mm	03.4823.01	03.4823.01B	03.4823.01G	03.4823.01O	03.4823.01R	03.4823.01Y
2500 mm	03.4825.01	03.4825.01B	03.4825.01G	03.4825.01O	03.4825.01R	03.4825.01Y
3000 mm	03.4830.01	03.4830.01B	03.4830.01G	03.4830.01O	03.4830.01R	03.4830.01Y
3500 mm	03.4835.01	03.4835.01B	03.4835.01G	03.4835.01O	03.4835.01R	03.4835.01Y
5000 mm	03.4850.01	03.4850.01B	03.4850.01G	03.4850.01O	03.4850.01R	03.4850.01Y



Fiber structure







Light source

Storz		KLA-L-101
ACMI		KLA-L-102
WOLF		KLA-L-103
OLYMPUS		KLA-L-104



Instrument side

Storz		KLA-I-201
ACMI		KLA-I-202
WOLF		KLA-I-203
OLYMPUS		KLA-I-204

(Different colours and lengths of cold light cables and different adapters are available upon request)