

Sterilization Container Systems

Secure Today
Elevate Tomorrow

 Different
Colors



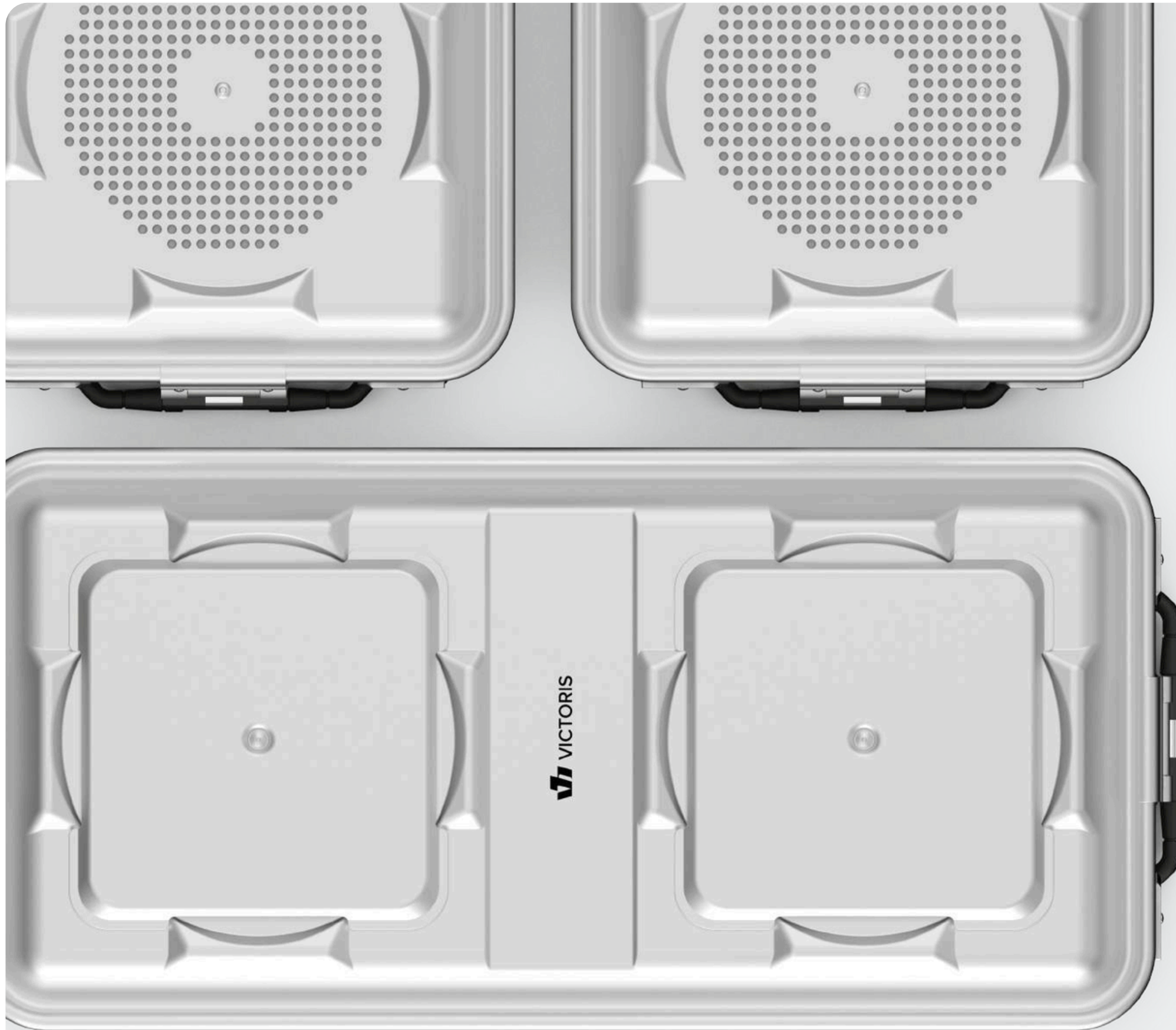

Table Of Contents

06	INTRODUCTION	15
16	STANDARD MODELS	35
36	REUSABLE MODELS	57
58	STERILIZATION BASKETS	67
68	ACCESSORIES & COMPONENTS	69
70	TROLLEYS & TABLES	71
72	INDEX	73

The Full Story

Victoris is more than a healthcare supply company; it's a testament to resilience, integrity, and a commitment to human values. Founded by two industry professionals who shared a vision for a workplace that prioritizes people over profit, our story began in the halls of an international medical device company. In the face of adversity, to create a company that not only thrives in the industry but serves as a beacon of compassion and ethical leadership. Victoris was born from the belief that success is measured not just in financial gains but in the positive impact a company can have on its employees and the community it serves.



Our Vision

At Victoris, our vision is to be a leader in healthcare solutions, recognized not only for the quality of our products but for the unwavering commitment to the well-being of our employees and the communities we serve. We envision a future where healthcare is not only about cutting-edge technology but also about compassionate and ethical practices, setting a benchmark for the industry.

Our Mission

Our mission at Victoris is twofold. Firstly, to provide exceptional healthcare products that enhance the lives of individuals undergoing medical procedures, for humans or pets. Secondly, to pioneer a corporate culture that prioritizes the welfare of our team members, recognizing them as the driving force behind our success. We are dedicated to fostering an environment that values diversity, upholds human rights, and serves as a beacon for responsible and ethical business practices.

Precision in Form, Compliance in Function

R&D

Experience the innovation driving Victoris with our dedicated Research and Development (R&D) division. Our R&D team is committed to pushing the boundaries of healthcare technology, continually developing breakthrough solutions to meet the evolving needs of the industry.

Utilizing cutting-edge technologies and advanced methodologies, our focus on rigorous testing and constant improvement ensures that each product meets the highest standards of quality and reliability. Trust in our relentless pursuit of excellence to elevate your operations and achieve unparalleled performance.

Production

Discover the excellence of Victoris production processes, designed to ensure precision, efficiency, and unparalleled quality. Our advanced production techniques are meticulously developed to deliver consistent results, ensuring that every product meets the highest standards of safety and reliability.

Spanning a closed production area of 2000 square meters, we leverage innovative technologies and streamlined workflows to minimize downtime and enhance productivity. Trust in our expertise to maintain the utmost quality and reliability in every aspect of your operations.

Regulatory / Quality

At Victoris, our unwavering commitment to quality, safety, and compliance, including adherence to regulatory bodies such as CE, FDA, and ISO, is the driving force behind everything we do. Our Regulatory Affairs and Quality Assurance department, at the heart of our operations, ensures that our products consistently meet the highest industry standards and comply with all relevant guidelines.

We understand that in the medical industry, quality is non-negotiable, which is why our RA/QA team is dedicated to upholding the most rigorous standards of product quality, safety, and effectiveness, leaving no stone unturned to meet or exceed the stringent requirements of the healthcare and veterinary sectors.

Navigating the complex landscape of regulatory compliance is essential, and our experienced regulatory affairs professionals stay up to date with the latest regulations, working diligently to secure the necessary approvals, certifications, and registrations from CE, FDA, ISO, and other relevant authorities. Furthermore, our commitment to Occupational Health and Safety Policy is integral to our operations, ensuring the well-being of our workforce and the quality of our products.

Technical Competencies

- Machining
- Subtractive Manufacturing
- Deep Drawing
- Die & Mold Making
- Chemical Coating
- Hard Anodization
- Silicone Forming
- Laser Welding
- OEM - ODM - PLM



Special Stackability Design



Place and Go Gasket

Shape / No Glue

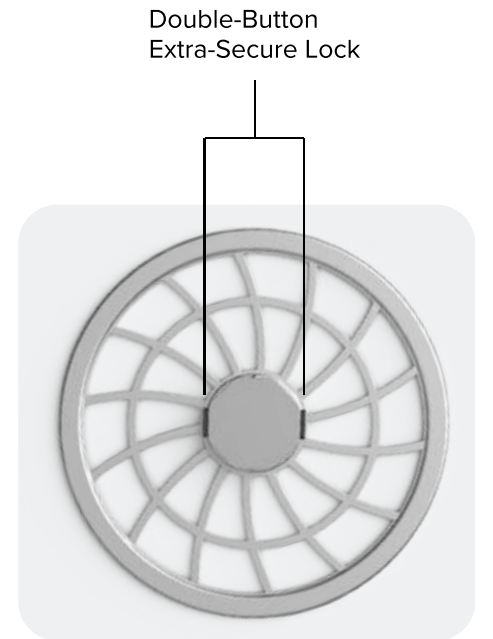

Double-Button Extra-Secure Lock

Filter Retainer With Sealing & Spring System

2 mm Aluminium Bottom & Lid

Spring-Loaded Aluminium Lock for Better Grip and Sealing

OEM-PLM Marking Option

Face Plate Made of Single Block of Aluminium

Extra-Strong Silicone Coated Ergonomic Handles





Different Lids Colors

Our sterilization containers at Victoris come in eight different colors (silver, yellow, red, blue, green, black, bronze and purple) ensuring to easily distinguish between different sets or types of instruments at a glance.



Advantages of Multiple Colors

- Enhanced Organization: Different colors can be used to categorize and organize instruments based on their usage, department, or level of sterilization, reducing the risk of cross-contamination and improving efficiency.
- Easy Identification: Color-coding helps in quickly identifying the contents of each container, saving time and reducing errors in busy environments.
- Improved Workflow: With a clear visual system in place, staff can more easily manage inventory and ensure that the right instruments are always in the right place.

Customized Solutions & Tailored to Your Needs

Victoris sterilization containers are manufactured in 8 main sizes to accommodate various surgical needs: standard sizes (1/1 Full Size, 3/4 Quarter Size, 1/2 Half Size, Mini, Dental and 1/2 Dental Size) are ideal for common instrument sets, while the Wide Body size suits specialized instruments like Bookwalter retractors, and the Long Body size is designed for extended instruments such as robotic arms.

The sterilization containers are crafted in five primary heights to suit a variety of surgical instruments. Additionally, custom sizes or heights can be tailored to meet specific requirements.

Standard 5 Different Heights For Standard & Reusable Models



Extra Long Size, Extra Wide Size, 1/1 Full Size, 3/4 Quarter Size, 1/2 Half Size

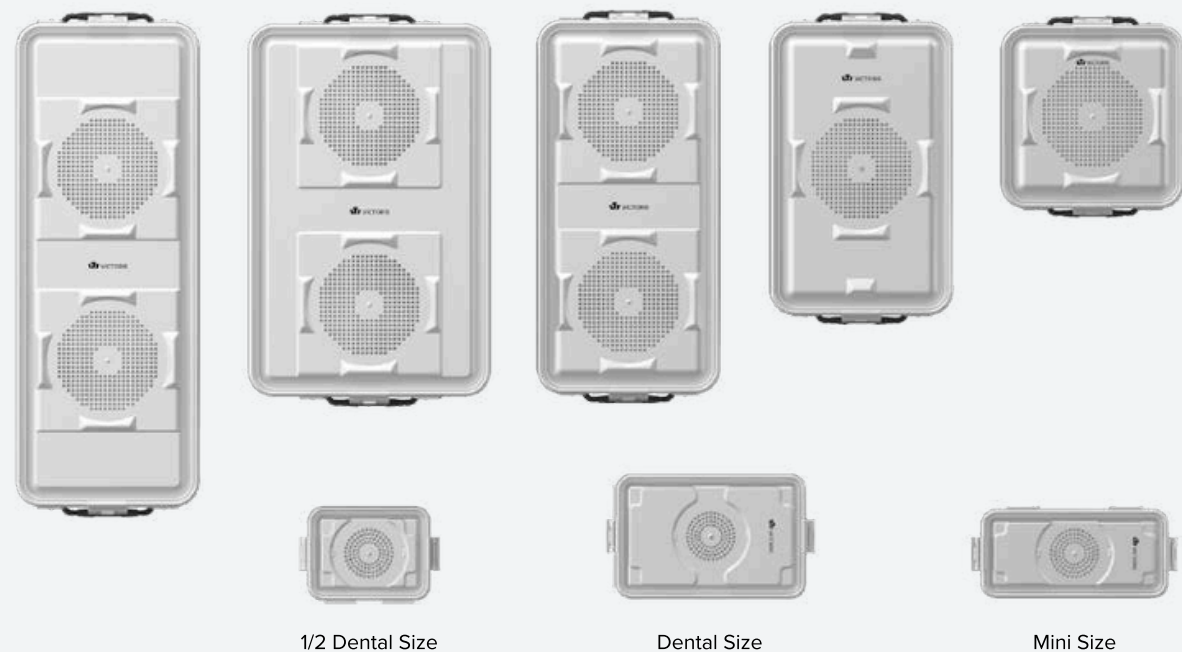

Standard 8 Different Size Types For Standard & Reusable Models

Type	Packaging according to EN 868-8		Steam sterilization procedure according to EN 285				
	Description	Symbolic Packaging	Gravity	Pre-Vacuum	Fractional Vacuum	Fractional Flow	Steam Injection
Sterilization Container with filters	Textiles in container with filter in lid and box		+	+	+	+	+
			O	O	+	+	+
	Textiles in container with filter in lid, non-perforated box		-	-	+	+	+
			-	-	+	+	O
	Textiles in container with filter in box, non-perforated lid		O	+	+	+	+
			-	O	+	+	+
	Instruments in wire basket, in sterilization filter in lid and box		+3	+	+	+	+
Instruments in wire basket, in sterilization container filter in lid and non-perforated box		-	+2	+2	+2	+2	
Sterilization Container with valves	Textiles in sterilization container with valves in lid and box		-	O	+	+	O
			-	-	+	+	O
	Textiles in sterilization container with valves in lid and no valves on the box		-	-	+	+	-
			-	-	+	+	-
	Instruments in wire basket in sterilization container with valve in lid and box		-	+2	+2	+2	+2
	Instruments in wire basket, in sterilization container with valve in lid and non-perforated box		-	+2	+2	+2	+2

*To prevent errors during service, operation, or loading of the autoclaves, consult above table.
 *Use only sterilization containers that guarantee proper evaporation or discharge of condensate.
 *Keep in mind that gravitation-based procedures, which lack a dedicated drying process, do not ensure sufficient after-drying effects.

STANDARD & REUSABLE MODELS

SECURE TODAY

ELEVATETOMORROW



WHY STERILIZATION CONTAINERS?

- Consistent Processing
- Reduced Risk of Contamination
- Physical Instrument Protection
- Optimal Set Organization
- Reusability / Sustainability
- Reduced Waste
- Streamlined Process
- Easy Identification and Access
- Adherence to Standards
- Minimized Handling

Today's Safety. Tomorrow's Efficiency



Different Lids Colors

victorishealth.com

Elevated Sterilization Solutions: For Your Operational Excellence

Discover our 2mm special alloy aluminum container systems that provide superior protection for your surgical instruments. Available in 8 different color palettes, they facilitate organization and quick identification. This solution supports your operational excellence by combining reliability, an eco-friendly approach, and long-term cost advantages.

SAFETY LIDS



TWO DIFFERENT FILTER TYPES
Paper Filter or PTFE Filter



EASE WITH COLORS
EXCELLENCE IN WORKFLOW

Different Lids Colors



TWO BOTTOM TYPES

Non Perforated Perforated



Standard Model

1/1FullSize

 Different Lids Colors



With Safety Lid



With Perforated Lid



Non Perforated



Code Outside Dimension Inside Dimension L x W x H

K1-10-110	595 x 270 x 95 mm 544 x 257 x 92 mm
K1-10-135	595 x 270 x 115 mm 544 x 257 x 113 mm
K1-10-150	595 x 270 x 140 mm 544 x 257 x 137 mm
K1-10-200	595 x 270 x 190 mm 544 x 257 x 187 mm
K1-10-260	595 x 270 x 250 mm 544 x 257 x 247 mm

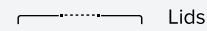

Lids



Colors	Code
Grey	K1-10-1
Yellow	K1-10-2
Green	K1-10-3
Blue	K1-10-4
Red	K1-10-5
Black	K1-10-6
Purple	K1-10-7
Bronze	K1-10-8

Dimension
585 x 285 mm



Perforated



Code Outside Dimension Inside Dimension L x W x H

KP1-10-110	595 x 270 x 95 mm 544 x 257 x 80 mm
KP1-10-135	595 x 270 x 115 mm 544 x 257 x 101 mm
KP1-10-150	595 x 270 x 140 mm 544 x 257 x 125 mm
KP1-10-200	595 x 270 x 190 mm 544 x 257 x 175 mm
KP1-10-260	595 x 270 x 250 mm 544 x 257 x 235 mm



Safety Lids



Colors	Code
Grey	KS1-10-1
Yellow	KS1-10-2
Green	KS1-10-3
Blue	KS1-10-4
Red	KS1-10-5
Black	KS1-10-6
Purple	KS1-10-7
Bronze	KS1-10-8

Dimension
605 x 287 mm

Wire Basket

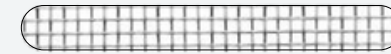

Mesh: 4x4 mm
Wire: ø 1 mm

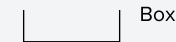

Box

Code	Outside Dimension L x W x H
B1-5425-30	540 x 255 x 30 mm
B1-5425-50	540 x 255 x 50 mm
B1-5425-70	540 x 255 x 70 mm
B1-5425-100	540 x 255 x 100 mm



Lid

Code	Outside Dimension L x W x H
B1-5425	510 x 240 x 5 mm

Perforated Basket



Mesh: 4x4 mm
Wire: ø 1 mm

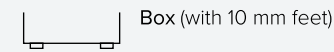

Box (with 10 mm feet)

Code	Outside Dimension L x W x H
B2-5425-30	540 x 253 x 40 mm
B2-5425-50	540 x 253 x 60 mm
B2-5425-70	540 x 253 x 80 mm
B2-5425-100	540 x 253 x 110 mm

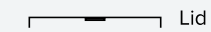

Lid

Code	Outside Dimension L x W x H
B2-5425	540 x 256 x 5 mm

Hybrid Basket



Mesh: 4x4 mm
Sides: ø 3 mm
Wire: ø 1 mm



Box

Code	Outside Dimension L x W x H
B3-5425-50	540 x 255 x 50 mm
B3-5425-70	540 x 255 x 70 mm
B3-5425-100	540 x 255 x 100 mm



Lid

Code	Outside Dimension L x W x H
B1-5425	540 x 255 x 5 mm

Silicone Mat



Code
A7-5425
Outside Dimension
L x W x H
500 x 235 mm

Standard Model

1/1 Full Size Baskets

Wire Basket



Perforated Basket

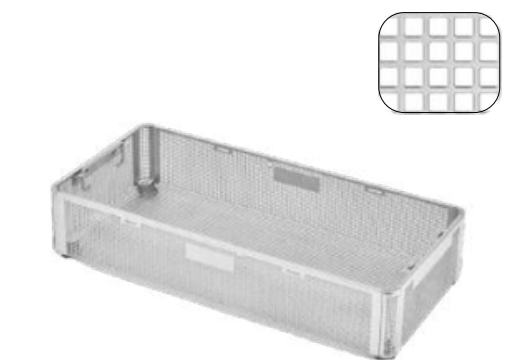

Hybrid Basket



Standard Model

3/4 Quarter Size

 Different Lids Colors



With Safety Lid



With Perforated Lid



Non Perforated



Code Outside Dimension
Inside Dimension
L x W x H

K1-20-110	470 x 270 x 95 mm 430 x 260 x 92 mm
K1-20-135	470 x 270 x 115 mm 430 x 260 x 101 mm
K1-20-150	470 x 270 x 140 mm 430 x 260 x 137 mm
K1-20-200	470 x 270 x 184 mm 430 x 260 x 178 mm



Perforated



Code Outside Dimension
Inside Dimension
L x W x H

KP1-20-110	470 x 270 x 95 mm 430 x 260 x 80 mm
KP1-20-135	470 x 270 x 115 mm 430 x 260 x 101 mm
KP1-20-150	470 x 270 x 140 mm 430 x 260 x 125 mm
KP1-20-200	470 x 270 x 184 mm 430 x 260 x 166 mm



Lids



Colors Code

Grey	K1-20-1
Yellow	K1-20-2
Green	K1-20-3
Blue	K1-20-4
Red	K1-20-5
Black	K1-20-6
Purple	K1-20-7
Bronze	K1-20-8

Dimension
465 x 285 mm



Safety Lids



Colors Code

Grey	KS1-20-1
Yellow	KS1-20-2
Green	KS1-20-3
Blue	KS1-20-4
Red	KS1-20-5
Black	KS1-20-6
Purple	KS1-20-7
Bronze	KS1-20-8

Dimension
482 x 287 mm

Wire Basket

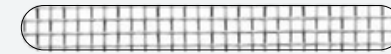

Mesh: 4x4 mm
Wire: ø 1 mm

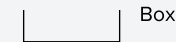

Box

Code	Outside Dimension L x W x H
B1-4025-30	405 x 255 x 30 mm
B1-4025-50	405 x 255 x 50 mm
B1-4025-70	405 x 255 x 70 mm
B1-4025-100	405 x 255 x 100 mm



Lid

Code	Outside Dimension L x W x H
B1-4025	375 x 240 x 5 mm

Perforated Basket



Mesh: 4x4 mm
Wire: ø 1 mm



Box (with 10 mm feet)

Code	Outside Dimension L x W x H
B2-4025-30	405 x 252 x 40 mm
B2-4025-50	405 x 252 x 60 mm
B2-4025-70	405 x 252 x 80 mm
B2-4025-100	405 x 252 x 110 mm



Lid

Code	Outside Dimension L x W x H
B2-4025	409 x 256 x 5 mm

Hybrid Basket



Mesh: 4x4 mm
Sides: ø 3 mm
Wire: ø 1 mm

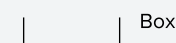

Box

Code	Outside Dimension L x W x H
B3-4025-50	405 x 245 x 50 mm
B3-4025-70	405 x 245 x 70 mm
B3-4025-100	405 x 245 x 100 mm

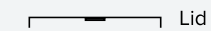

Lid

Code	Outside Dimension L x W x H
B1-4025	405 x 245 x 5 mm

Silicone Mat



Code
A7-4025
Outside Dimension
L x W x H
370 x 235 mm

Standard Model

3/4 Quarter Size Baskets

Wire Basket



Perforated Basket



Hybrid Basket



Standard Model

1/2 Half Size

 Different Lids Colors



With Safety Lid



With Perforated Lid



Code Outside Dimension
 Inside Dimension
 L x W x H

K1-30-110	300 x 270 x 95 mm 255 x 255 x 92 mm
K1-30-135	300 x 270 x 115 mm 255 x 255 x 113 mm
K1-30-150	300 x 270 x 140 mm 255 x 255 x 137 mm
K1-30-200	300 x 270 x 190 mm 255 x 255 x 187 mm
K1-30-260	300 x 270 x 250 mm 255 x 255 x 247 mm

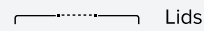

Colors	Code
Grey	K1-30-1
Yellow	K1-30-2
Green	K1-30-3
Blue	K1-30-4
Red	K1-30-5
Black	K1-30-6
Purple	K1-30-7
Bronze	K1-30-8

Dimension
295 x 285 mm



Code Outside Dimension
 Inside Dimension
 L x W x H

KP1-30-110	300 x 270 x 95 mm 255 x 255 x 80 mm
KP1-30-135	300 x 270 x 115 mm 255 x 255 x 101 mm
KP1-30-150	300 x 270 x 140 mm 255 x 255 x 125 mm
KP1-30-200	300 x 270 x 190 mm 255 x 255 x 175 mm
KP1-30-260	300 x 270 x 250 mm 255 x 255 x 235 mm



Colors	Code
Grey	KS1-30-1
Yellow	KS1-30-2
Green	KS1-30-3
Blue	KS1-30-4
Red	KS1-30-5
Black	KS1-30-6
Purple	KS1-30-7
Bronze	KS1-30-8

Dimension
315 x 287 mm

Wire Basket

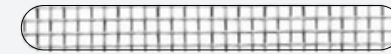

Code	Outside Dimension L x W x H
B1-2525-30	255 x 245 x 30 mm
B1-2525-50	255 x 245 x 50 mm
B1-2525-70	255 x 245 x 70 mm
B1-2525-100	255 x 245 x 100 mm

Mesh: 4x4 mm
Wire: ø 1 mm



Code	Outside Dimension L x W x H
B1-2525	240 x 215 x 5 mm

Perforated Basket

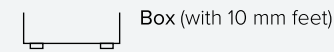

Code	Outside Dimension L x W x H
B2-2525-30	242 x 252 x 40 mm
B2-2525-50	242 x 252 x 60 mm
B2-2525-70	242 x 252 x 80 mm
B2-2525-100	242 x 252 x 110 mm

Mesh: 4x4 mm
Wire: ø 1 mm

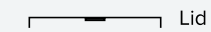

Code	Outside Dimension L x W x H
B2-2525	246 x 256 x 5 mm

Hybrid Basket

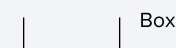

Code	Outside Dimension L x W x H
B3-2525-50	255 x 245 x 50 mm
B3-2525-70	255 x 245 x 70 mm
B3-2525-100	255 x 245 x 100 mm

Mesh: 4x4 mm
Sides: ø 3 mm
Wire: ø 1 mm



Code	Outside Dimension L x W x H
B1-2525	245 x 245 x 5 mm

Silicone Mat



Code	Outside Dimension L x W x H
A7-2525	225 x 235 mm

Standard Model

1/2 Half Size Baskets

Wire Basket

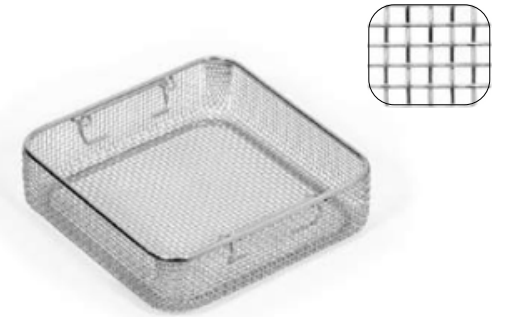

Perforated Basket

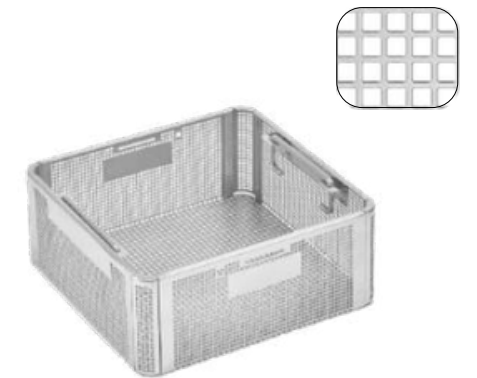

Hybrid Basket



Standard Model

Long Size

Different Lids Colors



With Perforated Lid



With Color Options



Non Perforated



Code Outside Dimension
 Inside Dimension
 L x W x H

K1-40-150	770 x 270 x 135 mm 720 x 260 x 130 mm
K1-40-200	770 x 270 x 190 mm 720 x 260 x 185 mm



Perforated



Code Outside Dimension
 Inside Dimension
 L x W x H

KP1-40-150	770 x 270 x 135 mm 720 x 260 x 118 mm
KP1-40-200	770 x 270 x 190 mm 720 x 260 x 173 mm

Lids

Colors Code

Grey K1-40-1

Yellow K1-40-2

Green K1-40-3

Blue K1-40-4

Red K1-40-5

Black K1-40-6

Purple K1-40-7

Bronze K1-40-8

Dimension
755 x 285 mm

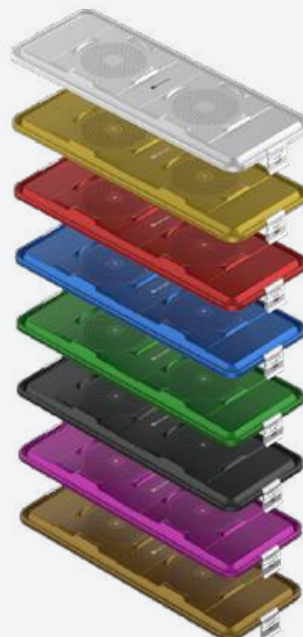

Wire Basket



Box

Code	Outside Dimension L x W x H
B1-6625-50	665 x 250 x 50 mm
B1-6625-70	665 x 250 x 70 mm
B1-6625-100	665 x 250 x 100 mm

Mesh: 4x4 mm
Wire: ø 1 mm



Lid

Code	Outside Dimension L x W x H
B1-6625	635 x 235 x 5 mm

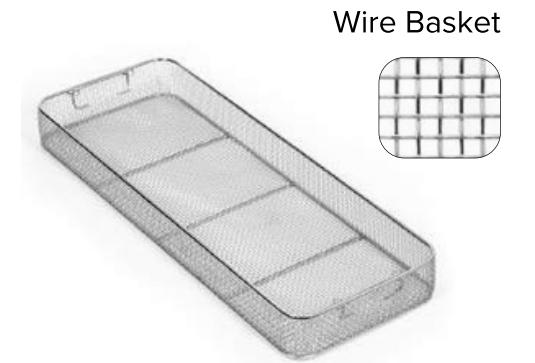

Wire Basket

Perforated Basket

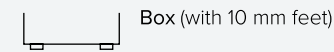

Box (with 10 mm feet)

Code	Outside Dimension L x W x H
B2-6625-30	665 x 253 x 40 mm
B2-6625-50	665 x 253 x 60 mm
B2-6625-70	665 x 253 x 80 mm
B2-6625-100	665 x 253 x 110 mm

Mesh: 4x4 mm
Wire: ø 1 mm

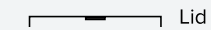

Lid

Code	Outside Dimension L x W x H
B2-6625	668 x 256 x 5 mm

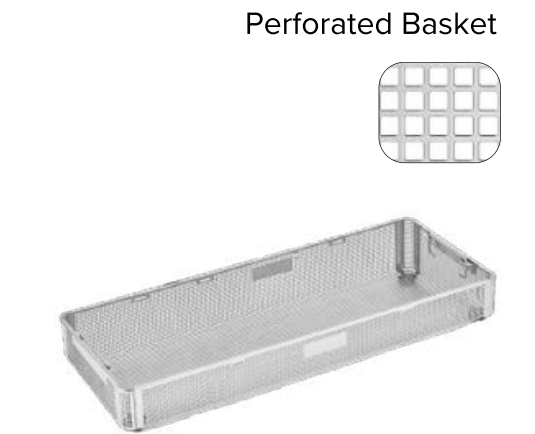

Perforated Basket

Hybrid Basket



Box

Code	Outside Dimension L x W x H
B3-6625-50	665 x 245 x 50 mm
B3-6625-70	665 x 245 x 70 mm
B3-6625-100	665 x 245 x 100 mm

Mesh: 4x4 mm
Sides: ø 3 mm
Wire: ø 1 mm



Lid

Code	Outside Dimension L x W x H
B1-6625	668 x 256 x 5 mm



Hybrid Basket

Standard Model

Long Size Baskets

Standard Model

WideSize

 Different Lids Colors



With Perforated Lid



With Color Options



Non Perforated



Code Outside Dimension
Inside Dimension
L x W x H

K1-50-110 595 x 365 x 105 mm
545 x 352 x 100 mm
K1-50-170 595 x 365 x 165 mm
545 x 352 x 160mm



Perforated



Code Outside Dimension
Inside Dimension
L x W x H

KP1-50-110 595 x 365 x 105 mm
545 x 352 x 88 mm
KP1-50-170 595 x 365 x 165 mm
545 x 352 x 148 mm

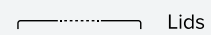

Lids

Colors Code

Grey K1-50-1
Yellow K1-50-2
Green K1-50-3
Blue K1-50-4
Red K1-50-5
Black K1-50-6
Purple K1-50-7
Bronze K1-50-8

Dimension
585 x 370 mm

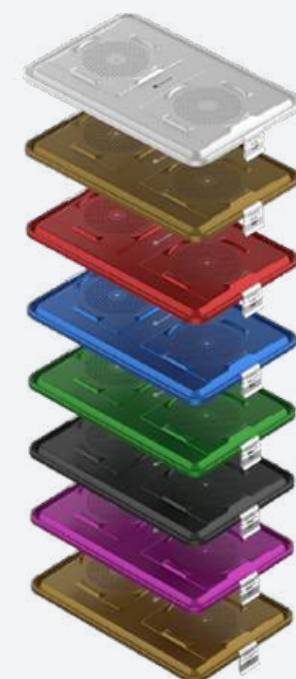

Wire Basket



Mesh: 4x4 mm
Wire: ø 1 mm

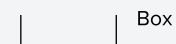

Box

Code Outside Dimension
L x W x H
B1-5333-50 533 x 337 x 50 mm
B1-5333-70 533 x 337 x 70 mm
B1-5333-100 533 x 337 x 100 mm

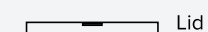

Lid

Code
B1-5333
Outside Dimension
L x W x H
533 x 337 x 5 mm

Perforated Basket



Mesh: 4x4 mm
Wire: ø 1 mm



Box (with 10 mm feet)

Code Outside Dimension
L x W x H
B2-5333-30 533 x 339 x 40 mm
B2-5333-50 533 x 339 x 60 mm
B2-5333-70 533 x 339 x 80 mm
B2-5333-100 533 x 339 x 110 mm



Lid

Code
B2-5333
Outside Dimension
L x W x H
534 x 343 x 5 mm

Hybrid Basket



Mesh: 4x4 mm
Sides: ø 3 mm
Wire: ø 1 mm

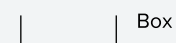

Box

Code Outside Dimension
L x W x H
B3-5333-50 533 x 337 x 50 mm
B3-5333-70 533 x 337 x 70 mm
B3-5333-100 533 x 337 x 100 mm



Lid

Code
B1-5333
Outside Dimension
L x W x H
533 x 337 x 5 mm

Standard Model

Wide Size Baskets

Wire Basket

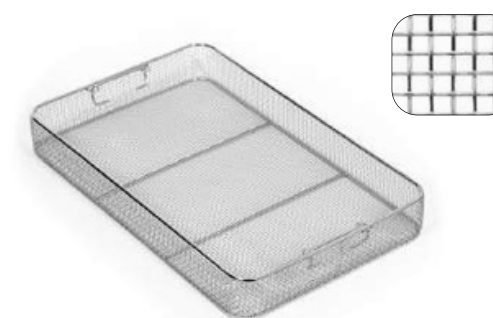

Perforated Basket



Hybrid Basket



Standard Model

FlatSize

 Different Lids Colors



With Perforated Lid



With Color Options



Code	Outside Dimension Inside Dimension L x W x H
K1-90-45	295 x 270 x 45 mm 255 x 255 x 41 mm
K1-90-75	295 x 270 x 75 mm 255 x 255 x 71 mm

Code	Outside Dimension L x W x H
B1-2525-30	255 x 245 x 30 mm
B1-2525-50	255 x 245 x 50 mm



Colors	Code
Grey	K1-90-1
Yellow	K1-90-2
Green	K1-90-3
Blue	K1-90-4
Red	K1-90-5
Black	K1-90-6
Purple	K1-90-7
Bronze	K1-90-8

Dimension
295 x 285 mm

Wire Basket

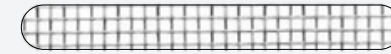

Code	Outside Dimension L x W x H
B1-2525-30	255 x 245 x 30 mm
B1-2525-50	255 x 245 x 50 mm

Mesh: 4x4 mm
Wire: ø 1 mm



Code	Outside Dimension L x W x H
B1-2525	240 x 215 x 5 mm

Perforated Basket



Code	Outside Dimension L x W x H
B2-2525-30	242 x 252 x 40 mm
B2-2525-50	242 x 252 x 60 mm

Mesh: 4x4 mm
Wire: ø 1 mm

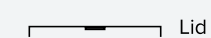

Code	Outside Dimension L x W x H
B2-2525	246 x 256 x 5 mm

Silicone Mat



Code	Outside Dimension L x W x H
A7-2525	225 x 235 mm

Standard Model

Flat Size Baskets

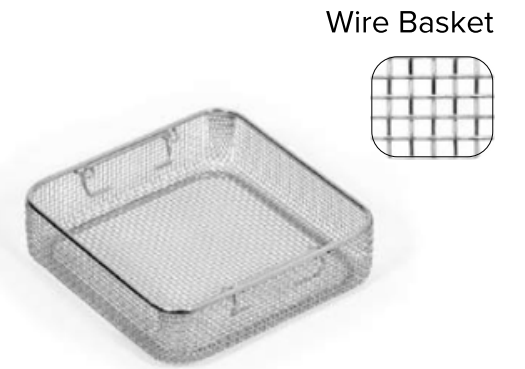

Wire Basket

Perforated Basket

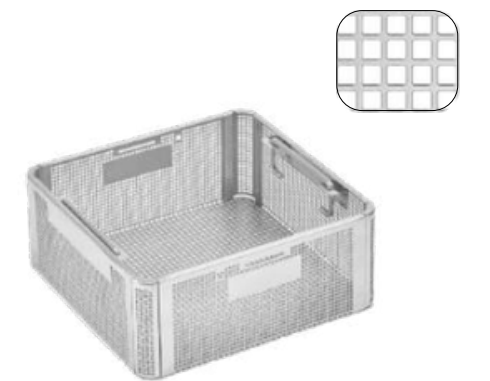

Standard Model

MiniSize

 Different Lids Colors



With Perforated Lid



With Color Options



Non Perforated

Code Outside Dimension
 Inside Dimension
 L x W x H

K1-70-40	315 x 130 x 40 mm 275 x 127 x 30 mm
K1-70-70	315 x 130 x 70 mm 275 x 127 x 60 mm
K1-70-100	315 x 130 x 100 mm 275 x 127 x 90 mm
K1-70-130	315 x 130 x 130 mm 275 x 127 x 120 mm

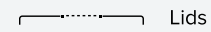

Lids

Colors Code

Grey	K1-70-1
Yellow	K1-70-2
Green	K1-70-3
Blue	K1-70-4
Red	K1-70-5
Black	K1-70-6
Purple	K1-70-7
Bronze	K1-70-8

Dimension
315 x 130 mm

Wire Basket



Mesh: 4x4 mm
Wire: ø 1 mm



Box

Code Outside Dimension
 L x W x H

B1-2712-40	270 x 117 x 40 mm
B1-2712-100	268 x 117 x 100 mm

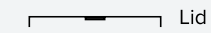

Lid

Code
B1-2712

Outside Dimension
L x W x H
270 x 117 x 5 mm

Perforated Basket



Mesh: 4x4 mm
Wire: ø 1 mm



Box (with 10 mm feet)

Code Outside Dimension
 L x W x H

B2-2712-40	265 x 125 x 50 mm
B2-2712-100	265 x 125 x 110 mm



Lid

Code
B2-2712

Outside Dimension
L x W x H
268 x 128 x 5 mm

Silicone Mat



Code
A7-2712
Outside Dimension
L x W x H
270 x 125 mm

Standard Model

Mini Size Baskets

Wire Basket



Perforated Basket

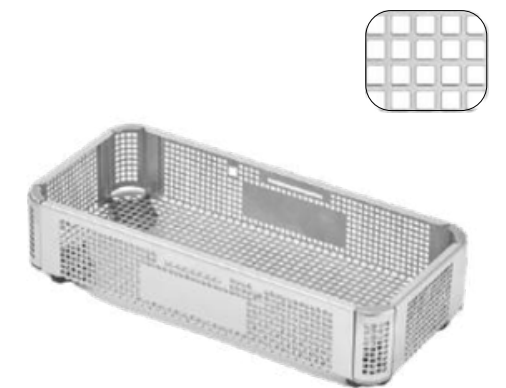

Standard Model

DentalSize

 Different Lids Colors



With Perforated Lid



With Color Options



Non Perforated

Code	Outside Dimension Inside Dimension L x W x H
K1-60-40	320 x 185 x 40 mm 280 x 182 x 30 mm
K1-60-70	320 x 185 x 70 mm 280 x 182 x 40 mm
K1-60-100	320 x 185 x 100 mm 280 x 182 x 90 mm
K1-60-130	320 x 185 x 130 mm 280 x 182 x 120 mm

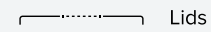

Colors	Code
Grey	K1-60-1
Yellow	K1-60-2
Green	K1-60-3
Blue	K1-60-4
Red	K1-60-5
Black	K1-60-6
Purple	K1-60-7
Bronze	K1-60-8

Dimension
325 x 190 mm

Wire Basket



Mesh: ϕ 4x4 mm
Wire: ϕ 1 mm

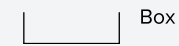

Code	Outside Dimension L x W x H
B1-2717-40	270 x 170 x 40 mm
B1-2717-100	270 x 170 x 100 mm



Code	Outside Dimension L x W x H
B1-2717	270 x 170 x 5 mm

Perforated Basket



Mesh: ϕ 4x4 mm
Wire: ϕ 1 mm

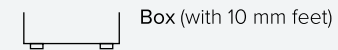

Code	Outside Dimension L x W x H
B2-2717-40	275 x 175 x 50 mm
B2-2717-100	275 x 175 x 110 mm



Code	Outside Dimension L x W x H
B2-2717	278 x 178 x 5 mm

Standard Model

Dental Size Baskets

Wire Basket

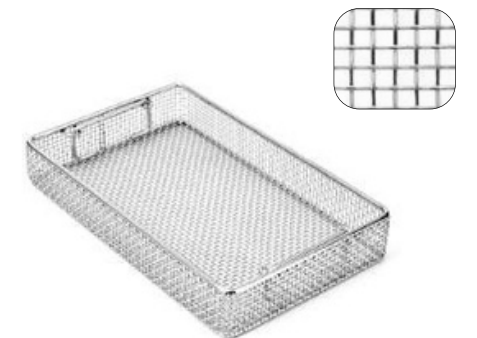

Perforated Basket



Standard Model

1/2DentalSize

 Different Lids Colors



With Perforated Lid



With Color Options



Non Perforated

Code	Outside Dimension Inside Dimension L x W x H
------	--

K1-80-40	225 x 160 x 40 mm 190 x 157 x 30 mm
K1-80-70	225 x 160 x 70 mm 190 x 157 x 60 mm
K1-80-100	225 x 160 x 100 mm 190 x 157 x 90 mm 225 x 160 x 130 mm
K1-80-130	190 x 157 x 120 mm

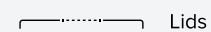

Lids

Colors	Code
--------	------

Grey	K1-80-1
Yellow	K1-80-2
Green	K1-80-3
Blue	K1-80-4
Red	K1-80-5
Black	K1-80-6
Purple	K1-80-7
Bronze	K1-80-8

Dimension
230 x 175 mm

Wire Basket



Mesh: \varnothing 4x4 mm
Wire: \varnothing 1 mm



Box

Code	Outside Dimension L x W x H
------	--------------------------------

B1-1714-40	175 x 145 x 40 mm
B1-1714-100	175 x 145 x 100 mm



Lid

Code
B1-1714

Outside Dimension
L x W x H
175 x 145 x 5 mm



Wire Basket

Perforated Basket



Mesh: \varnothing 4x4 mm
Wire: \varnothing 1 mm



Box (with 10 mm feet)

Code	Outside Dimension L x W x H
------	--------------------------------

B2-1714-40	175 x 145 x 50 mm
B2-1714-100	175 x 145 x 110 mm



Lid

Code
B2-1714

Outside Dimension
L x W x H
178 x 148 x 5 mm



Perforated Basket

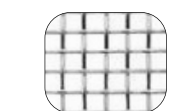
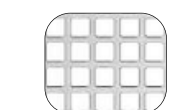

Wire Basket

Perforated Basket

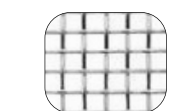

Wire Basket

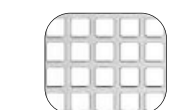

Perforated Basket

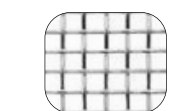

Wire Basket

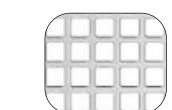

Perforated Basket

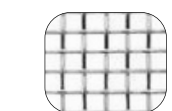

Wire Basket

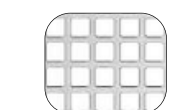

Perforated Basket



Wire Basket

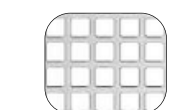

Perforated Basket

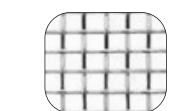

Wire Basket

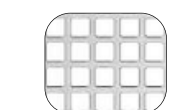

Perforated Basket

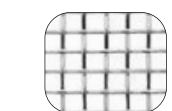

Wire Basket

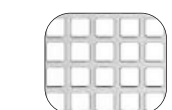

Perforated Basket



Wire Basket

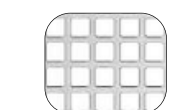

Perforated Basket

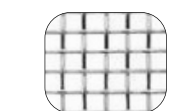

Wire Basket

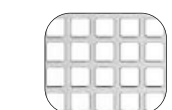

Perforated Basket

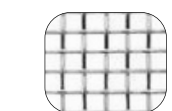

Wire Basket

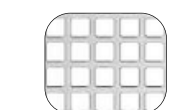

Perforated Basket

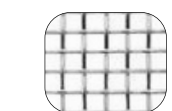

Wire Basket

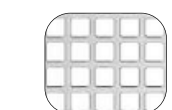

Perforated Basket

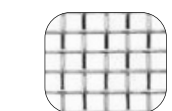

Wire Basket

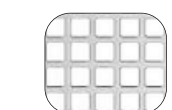

Perforated Basket

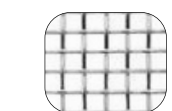

Wire Basket

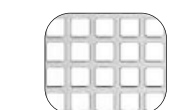

Perforated Basket

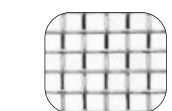

Wire Basket

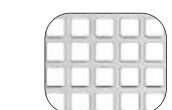

Perforated Basket

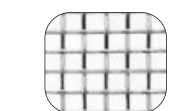

Wire Basket

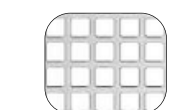

Perforated Basket

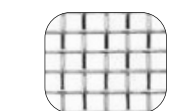

Wire Basket

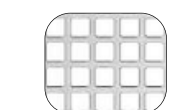

Perforated Basket

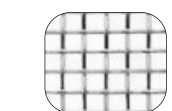

Wire Basket

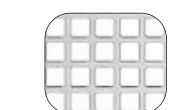

Perforated Basket



Wire Basket

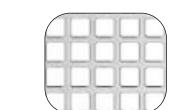

Perforated Basket

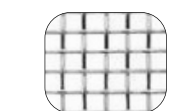

Wire Basket

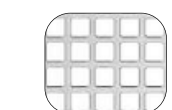

Perforated Basket

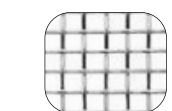

Wire Basket

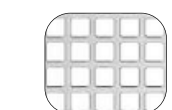

Perforated Basket

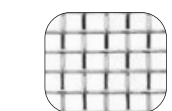

Wire Basket

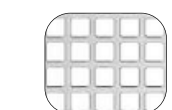

Perforated Basket

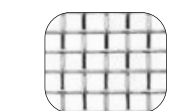

Wire Basket

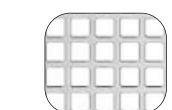

Perforated Basket

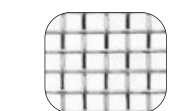

Wire Basket

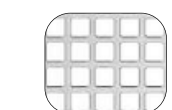

Perforated Basket



Wire Basket

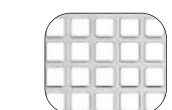

Perforated Basket

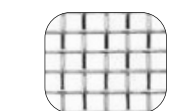

Wire Basket

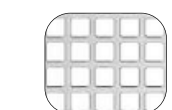

Perforated Basket

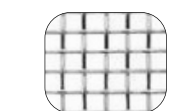

Wire Basket

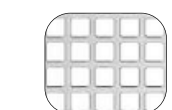

Perforated Basket

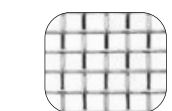

Wire Basket



Perforated Basket

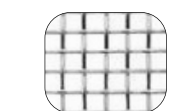

Wire Basket

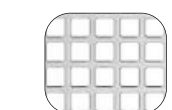

Perforated Basket



Wire Basket

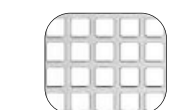

Perforated Basket



Wire Basket

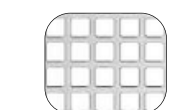

Perforated Basket

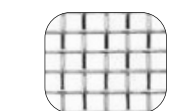

Wire Basket

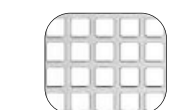

Perforated Basket

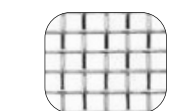

Wire Basket

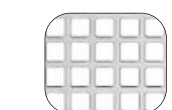

Perforated Basket

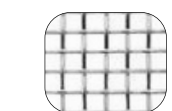

Wire Basket

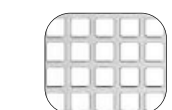

Perforated Basket

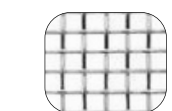

Wire Basket

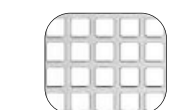

Perforated Basket

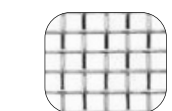

Wire Basket

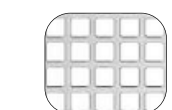

Perforated Basket

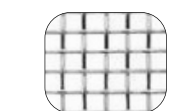

Wire Basket

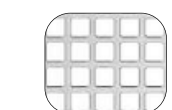

Perforated Basket

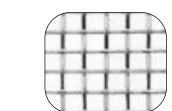

Wire Basket

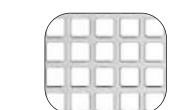

Perforated Basket

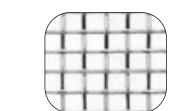

Wire Basket

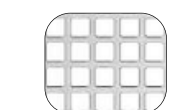

Perforated Basket

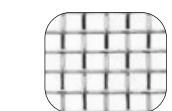

Wire Basket

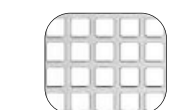

Perforated Basket

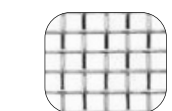

Wire Basket

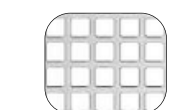

Perforated Basket



Wire Basket

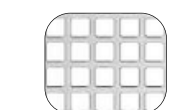

Perforated Basket

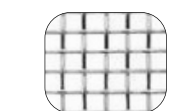

Wire Basket

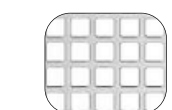

Perforated Basket

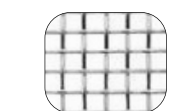

Wire Basket

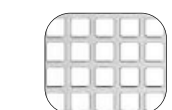

Perforated Basket

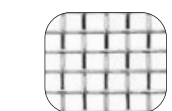

Wire Basket

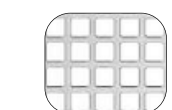

Perforated Basket

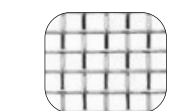

Wire Basket

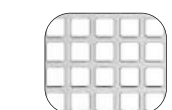

Perforated Basket

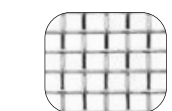

Wire Basket

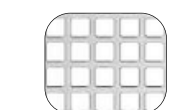

Perforated Basket



Wire Basket

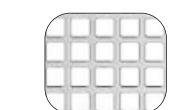

Perforated Basket



Wire Basket

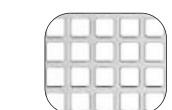

Perforated Basket

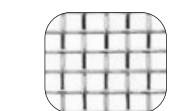

Wire Basket

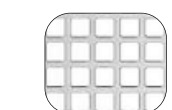

Perforated Basket

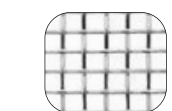

Wire Basket

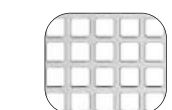

Perforated Basket

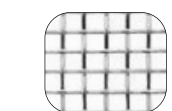

Wire Basket

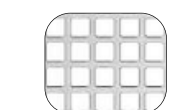

Perforated Basket

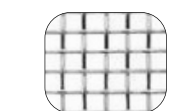

Wire Basket

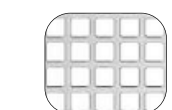

Perforated Basket

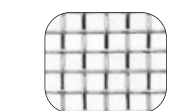

Wire Basket

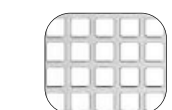

Perforated Basket



Wire Basket

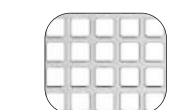

Perforated Basket

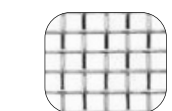

Wire Basket

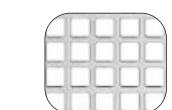

Perforated Basket



Wire Basket

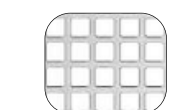

Perforated Basket

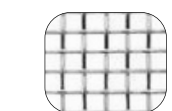

Wire Basket

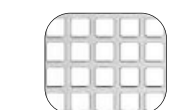

Clean. Safe. Sustainable.

2 Different Filtering System
Mechanical Valve System & Barrier System



Different Lids Colors

victorishealth.com

BARRIER MODEL

The Barrier Model is an innovative sterilization container designed to ensure maximum safety in CSSD workflows. Its labyrinth structure prevents microorganisms from entering, maintaining sterility for extended periods. This design offers reliable, practical, and scientifically proven protection.

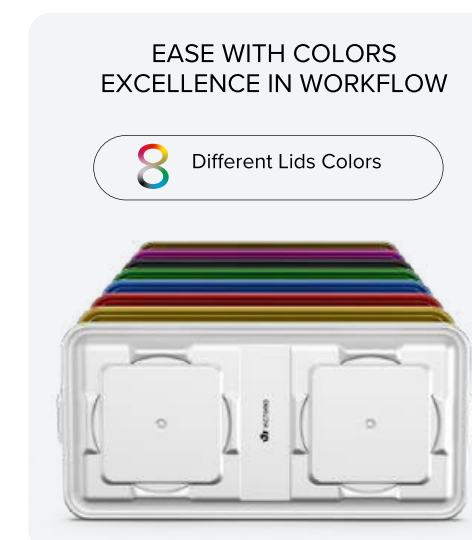
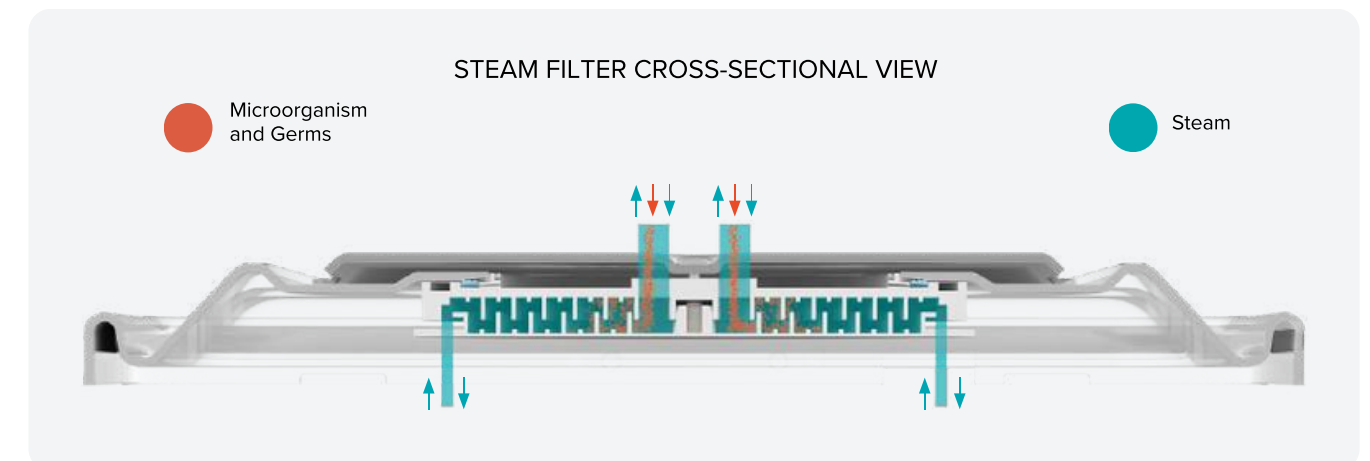

Scientific Foundation

The principle behind the Barrier mechanism traces back to Louis Pasteur's groundbreaking "Swan Neck Flask" experiment in 1862, which challenged the idea of spontaneous generation. Pasteur designed a flask with an S-shaped neck that allowed air to pass freely but trapped dust and microorganisms in its curves. When the broth inside was boiled and left untouched, no microbial growth occurred, clearly proving that life could not emerge without contamination from existing microorganisms. However, once the flask was tilted and the trapped particles reached the broth, microbial growth appeared almost immediately. The Barrier Model adopts the same principle through its labyrinth-like system. By forcing air to travel through a complex path, it prevents microorganisms and viruses from penetrating the container. This ensures that sterility is maintained, while still allowing necessary airflow. The result is a reliable and scientifically validated protective system, directly inspired by one of the most important experiments in microbiology.

REDUCE. REUSE. RENEW.

Seize Cost Control and Sustainability: Ditch the waste expense and embrace the smart, permanent solution.



VALVE MODEL

Victoris Valve Model sterilization containers are designed with an advanced mechanical valve system that removes the need for disposable filters while delivering stable and reliable performance throughout extended use. Each valve is precisely engineered with integrated gaskets that ensure smooth operation in response to pressure variations during the sterilization process. The secure closure, supported by high-grade silicone gaskets, provides excellent sealing integrity and long-term durability. Combining innovative design with practicality, Victoris Valve Model containers offer a sustainable and cost-efficient solution for safe and effective sterilization in healthcare environments worldwide.

EASE WITH COLORS EXCELLENCE IN WORKFLOW

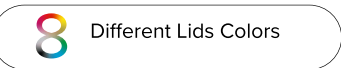

RUNNING PRINCIPLE

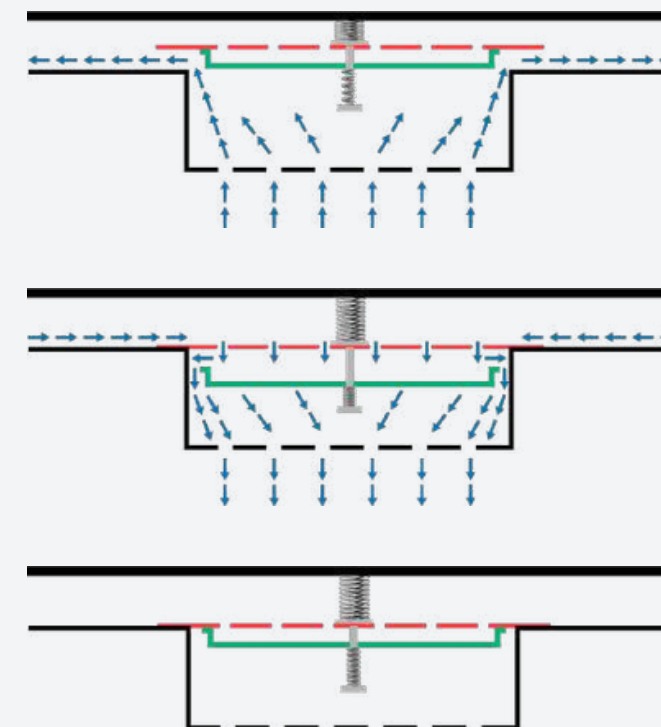

At the beginning of the sterilization cycle, the vacuum phase causes the valves to fully open, allowing the evacuation of dry air from the container.

During the sterilization cycle, the pressure-activated valves automatically open under positive pressure, enabling controlled steam penetration for effective sterilization.

Once the process is complete, and no external forces such as vacuum or pressure are present, the entire system remains sealed, preserving the sterility of its contents.

Reusable Model

1/1FullSize

 Different Lids Colors



With Reusable Mechanism



With Color Options

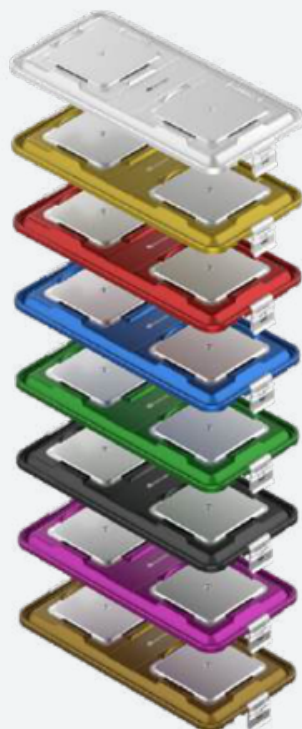

Non Perforated

Code	Outside Dimension Inside Dimension L x W x H
K1-10-110	595 x 270 x 95 mm 544 x 257 x 92 mm
K1-10-135	595 x 270 x 115 mm 544 x 257 x 113 mm
K1-10-150	595 x 270 x 140 mm 544 x 257 x 137 mm
K1-10-160	595 x 270 x 190 mm 544 x 257 x 187 mm
K1-10-200	595 x 270 x 250 mm 544 x 257 x 247 mm
K1-10-260	

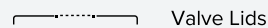

Valve Lids

Colors	Code
Grey	K2-10-1
Yellow	K2-10-2
Green	K2-10-3
Blue	K2-10-4
Red	K2-10-5
Black	K2-10-6
Purple	K2-10-7
Bronze	K2-10-8

Dimension
585 x 285 mm

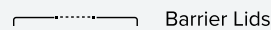

Barrier Lids

Colors	Code
Grey	K3-10-1
Yellow	K3-10-2
Green	K3-10-3
Blue	K3-10-4
Red	K3-10-5
Black	K3-10-6
Purple	K3-10-7
Bronze	K3-10-8

Dimension
585 x 285 mm

Wire Basket

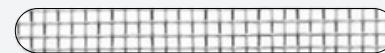

Mesh: 4x4 mm
Wire: ø 1 mm

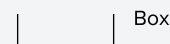

Box

Code	Outside Dimension L x W x H
B1-5425-30	540 x 255 x 30 mm
B1-5425-50	540 x 255 x 50 mm
B1-5425-70	540 x 255 x 70 mm
B1-5425-100	540 x 255 x 100 mm



Lid

Code	Outside Dimension L x W x H
B1-5425	510 x 240 x 5 mm

Perforated Basket



Mesh: 4x4 mm
Wire: ø 1 mm

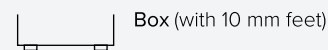

Box (with 10 mm feet)

Code	Outside Dimension L x W x H
B2-5425-30	540 x 253 x 40 mm
B2-5425-50	540 x 253 x 60 mm
B2-5425-70	540 x 253 x 80 mm
B2-5425-100	540 x 253 x 110 mm



Lid

Code	Outside Dimension L x W x H
B2-5425	540 x 256 x 5 mm

Hybrid Basket



Mesh: 4x4 mm
Sides: ø 3 mm
Wire: ø 1 mm

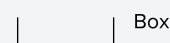

Box

Code	Outside Dimension L x W x H
B3-5425-50	540 x 255 x 50 mm
B3-5425-70	540 x 255 x 70 mm
B3-5425-100	540 x 255 x 100 mm



Lid

Code	Outside Dimension L x W x H
B1-5425	540 x 255 x 5 mm

Silicone Mat



Code
A7-5425
Outside Dimension
L x W x H
500 x 235 mm

Reusable Model

1/1 Full Size Baskets

Wire Basket



Perforated Basket

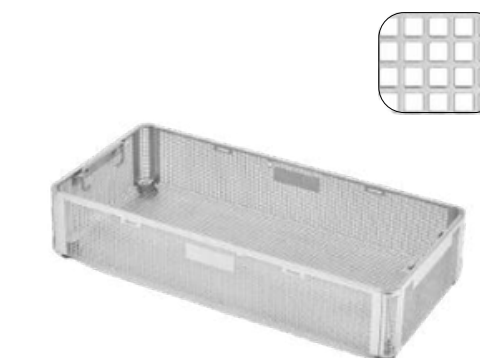

Hybrid Basket



Reusable Model

3/4 Quarter Size

Different Lids Colors



With Reusable Mechanism



With Color Options



Non Perforated

Code Outside Dimension Inside Dimension L x W x H

- K1-20-100 430 x 260 x 95 mm
- K1-20-135 470 x 270 x 115 mm
- K1-20-135 430 x 260 x 101 mm
- K1-20-150 470 x 270 x 140 mm
- K1-20-150 430 x 260 x 137 mm
- K1-20-200 470 x 270 x 184 mm
- K1-20-200 430 x 260 x 178 mm



Valve Lids

Colors Code

- Grey K2-20-1
- Yellow K2-20-2
- Green K2-20-3
- Blue K2-20-4
- Red K2-20-5
- Black K2-20-6
- Purple K2-20-7
- Bronze K2-20-8

Dimension 465 x 285 mm



Barrier Lids

Colors Code

- Grey K3-20-1
- Yellow K3-20-2
- Green K3-20-3
- Blue K3-20-4
- Red K3-20-5
- Black K3-20-6
- Purple K3-20-7
- Bronze K3-20-8

Dimension 465 x 285 mm

Wire Basket



Mesh: 4x4 mm
Wire: ø 1 mm



Box

Code	Outside Dimension L x W x H
B1-4025-30	405 x 255 x 30 mm
B1-4025-50	405 x 255 x 50 mm
B1-4025-70	405 x 255 x 70 mm
B1-4025-100	405 x 255 x 100 mm



Lid

Code	Outside Dimension L x W x H
B1-4025	375 x 240 x 5 mm

Perforated Basket



Mesh: 4x4 mm
Wire: ø 1 mm

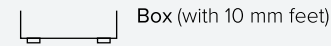

Box (with 10 mm feet)

Code	Outside Dimension L x W x H
B2-4025-30	405 x 252 x 40 mm
B2-4025-50	405 x 252 x 60 mm
B2-4025-70	405 x 252 x 80 mm
B2-4025-100	405 x 252 x 110 mm



Lid

Code	Outside Dimension L x W x H
B2-4025	409 x 256 x 5 mm

Hybrid Basket

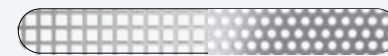

Mesh: 4x4 mm
Sides: ø 3 mm
Wire: ø 1 mm

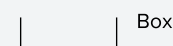

Box

Code	Outside Dimension L x W x H
B3-4025-50	405 x 245 x 50 mm
B3-4025-70	405 x 245 x 70 mm
B3-4025-100	405 x 245 x 100 mm



Lid

Code	Outside Dimension L x W x H
B1-4025	405 x 245 x 5 mm

Silicone Mat



Code A7-4025
Outside Dimension L x W x H 370 x 235 mm

Reusable Model

3/4 Quarter Size Baskets

Wire Basket



Perforated Basket

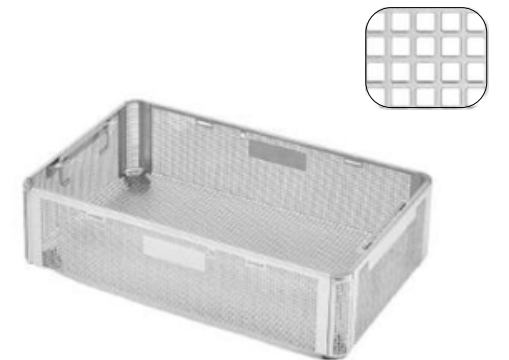

Hybrid Basket



Reusable Model

1/2 Half Size

 Different Lids Colors



With Reusable Mechanism



With Color Options



Non Perforated

Code	Outside Dimension Inside Dimension L x W x H
K1-30-110	300 x 270 x 95 mm 255 x 255 x 92 mm
K1-30-135	300 x 270 x 115 mm 255 x 255 x 113 mm
K1-30-150	300 x 270 x 140 mm 255 x 255 x 137 mm
K1-30-200	300 x 270 x 190 mm 255 x 255 x 187 mm
K1-30-260	300 x 270 x 250 mm 255 x 255 x 247 mm



Valve Lids

Colors	Code
Grey	K2-30-1
Yellow	K2-30-2
Green	K2-30-3
Blue	K2-30-4
Red	K2-30-5
Black	K2-30-6
Purple	K2-30-7
Bronze	K2-30-8

Dimension
295 x 285 mm



Barrier Lids

Colors	Code
Grey	K3-30-1
Yellow	K3-30-2
Green	K3-30-3
Blue	K3-30-4
Red	K3-30-5
Black	K3-30-6
Purple	K3-30-7
Bronze	K3-30-8

Dimension
295 x 285 mm

Wire Basket

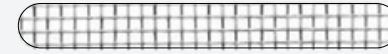

Mesh: 4x4 mm
Wire: ø 1 mm



Box

Code	Outside Dimension L x W x H
B1-2525-30	255 x 245 x 30 mm
B1-2525-50	255 x 245 x 50 mm
B1-2525-70	255 x 245 x 70 mm
B1-2525-100	255 x 245 x 100 mm



Lid

Code	Outside Dimension L x W x H
B1-2525	240 x 215 x 5 mm

Perforated Basket



Mesh: 4x4 mm
Wire: ø 1 mm

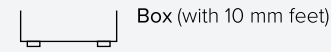

Box (with 10 mm feet)

Code	Outside Dimension L x W x H
B2-2525-30	242 x 252 x 40 mm
B2-2525-50	242 x 252 x 60 mm
B2-2525-70	242 x 252 x 80 mm
B2-2525-100	242 x 252 x 110 mm



Lid

Code	Outside Dimension L x W x H
B2-2525	246 x 256 x 5 mm

Hybrid Basket



Mesh: 4x4 mm
Sides: ø 3 mm
Wire: ø 1 mm



Box

Code	Outside Dimension L x W x H
B3-2525-50	255 x 245 x 50 mm
B3-2525-70	255 x 245 x 70 mm
B3-2525-100	255 x 245 x 100 mm



Lid

Code	Outside Dimension L x W x H
B1-2525	245 x 245 x 5 mm

Silicone Mat



Code	Outside Dimension L x W x H
A7-2525	225 x 235 mm

Reusable Model

1/2 Half Size Baskets

Wire Basket



Perforated Basket

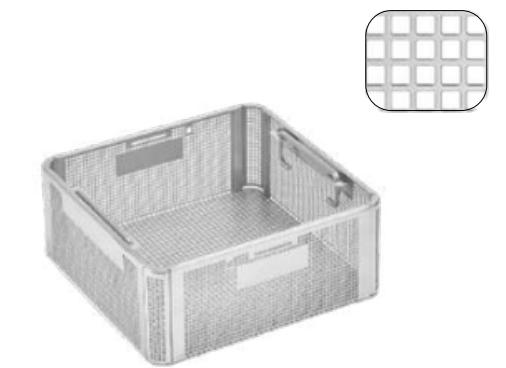

Hybrid Basket



Reusable Model

Long Size

 Different Lids Colors



With Reusable Mechanism



With Color Options

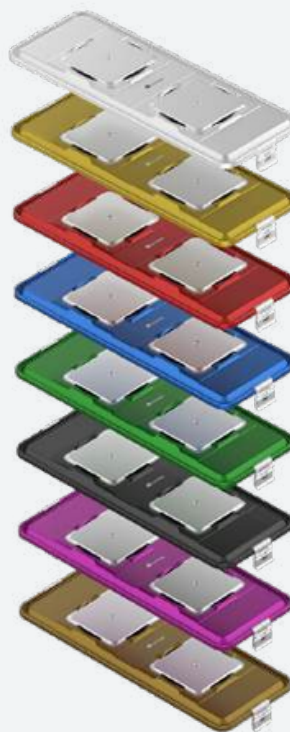

Code	Outside Dimension Inside Dimension L x W x H
K1-40-150	770 x 270 x 135 mm 720 x 260 x 130 mm
K1-40-200	770 x 270 x 190 mm 720 x 260 x 185 mm

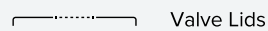

Colors	Code
Grey	K2-40-1
Yellow	K2-40-2
Green	K2-40-3
Blue	K2-40-4
Red	K2-40-5
Black	K2-40-6
Purple	K2-40-7
Bronze	K2-40-8

Dimension
770 x 270 mm



Colors	Code
Grey	K3-40-1
Yellow	K3-40-2
Green	K3-40-3
Blue	K3-40-4
Red	K3-40-5
Black	K3-40-6
Purple	K3-40-7
Bronze	K3-40-8

Dimension
770 x 270 mm

Wire Basket



Code	Outside Dimension L x W x H
B1-6625-50	665 x 250 x 50 mm
B1-6625-70	665 x 250 x 70 mm
B1-6625-100	665 x 250 x 100 mm

Mesh: 4x4 mm
Wire: ø 1 mm



Code	Outside Dimension L x W x H
B1-6625	635 x 235 x 5 mm

Perforated Basket



Code	Outside Dimension L x W x H
B2-6625-30	665 x 253 x 40 mm
B2-6625-50	665 x 253 x 60 mm
B2-6625-70	665 x 253 x 80 mm
B2-6625-100	665 x 253 x 110 mm

Mesh: 4x4 mm
Wire: ø 1 mm



Code	Outside Dimension L x W x H
B2-6625	668 x 256 x 5 mm

Hybrid Basket



Code	Outside Dimension L x W x H
B3-6625-50	665 x 245 x 50 mm
B3-6625-70	665 x 245 x 70 mm
B3-6625-100	665 x 245 x 100 mm

Mesh: 4x4 mm
Sides: ø 3 mm
Wire: ø 1 mm



Code	Outside Dimension L x W x H
B1-6625	668 x 256 x 5 mm

Reusable Model

Long Size Baskets

Wire Basket



Perforated Basket

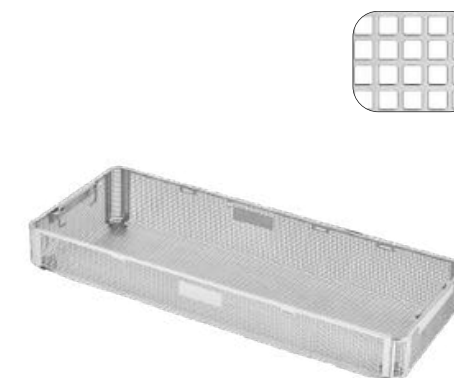

Hybrid Basket

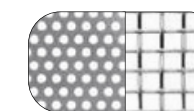
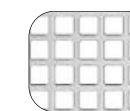
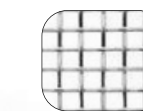

Reusable Model

Wide Size

Different Lids Colors



With Reusable Mechanism



With Color Options

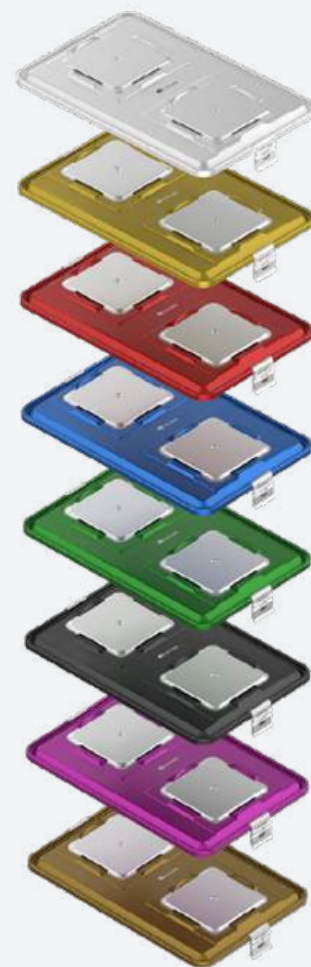

Code	Outside Dimension Inside Dimension L x W x H
K1-50-110	595 x 365 x 105 mm 545 x 352 x 100 mm
K1-50-170	595 x 365 x 165 mm 545 x 352 x 160mm



Colors	Code
Grey	K2-50-1
Yellow	K2-50-2
Green	K2-50-3
Blue	K2-50-4
Red	K2-50-5
Black	K2-50-6
Purple	K2-50-7
Bronze	K2-50-8

Dimension
585 x 370 mm

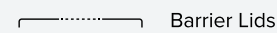

Colors	Code
Grey	K3-50-1
Yellow	K3-50-2
Green	K3-50-3
Blue	K3-50-4
Red	K3-50-5
Black	K3-50-6
Purple	K3-50-7
Bronze	K3-50-8

Dimension
585 x 370 mm

Wire Basket



Mesh: 4x4 mm
Wire: ø 1 mm



Code	Outside Dimension L x W x H
B1-5333-50	533 x 337 x 50 mm
B1-5333-70	533 x 337 x 70 mm
B1-5333-100	533 x 337 x 100 mm

Code	Outside Dimension L x W x H
B1-5333	533 x 337 x 5 mm

Perforated Basket



Mesh: 4x4 mm
Wire: ø 1 mm



Code	Outside Dimension L x W x H
B2-5333-30	533 x 339 x 40 mm
B2-5333-50	533 x 339 x 60 mm
B2-5333-70	533 x 339 x 80 mm
B2-5333-100	533 x 339 x 110 mm

Code	Outside Dimension L x W x H
B2-5333	534 x 343 x 5 mm

Hybrid Basket



Mesh: 4x4 mm
Sides: ø 3 mm
Wire: ø 1 mm

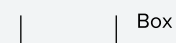

Code	Outside Dimension L x W x H
B3-5333-50	533 x 337 x 50 mm
B3-5333-70	533 x 337 x 70 mm
B3-5333-100	533 x 337 x 100 mm

Code	Outside Dimension L x W x H
B1-5333	533 x 337 x 5 mm

Reusable Model

Wide Size Baskets

Wire Basket



Perforated Basket



Hybrid Basket



Reusable Model

Flat Size

 Different Lids Colors



With Reusable Mechanism



With Color Options



Non Perforated

Code Outside Dimension
 Inside Dimension
 L x W x H

K1-90-75 295 x 270 x 75 mm
 255 x 255 x 71 mm

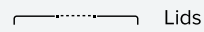

Lids

Colors Code

Grey K3-90-1

Yellow K3-90-2

Green K3-90-3

Blue K3-90-4

Red K3-90-5

Black K3-90-6

Purple K3-90-7

Bronze K3-90-8

Dimension
295 x 285 mm

Wire Basket

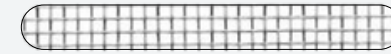

Mesh: 4x4 mm
Wire: ø 1 mm



Box

Code Outside Dimension
 L x W x H

B1-2525-30 255 x 245 x 30 mm

B1-2525-50 255 x 245 x 50 mm



Lid

Code
B1-2525

Outside Dimension
L x W x H
240 x 215 x 5 mm

Perforated Basket



Mesh: 4x4 mm
Wire: ø 1 mm

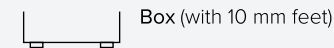

Box (with 10 mm feet)

Code Outside Dimension
 L x W x H

B2-2525-30 242 x 252 x 40 mm

B2-2525-50 242 x 252 x 60 mm



Lid

Code
B2-2525

Outside Dimension
L x W x H
246 x 256 x 5 mm

Silicone Mat



Code
A7-2525

Outside Dimension
L x W x H
225 x 235 mm

Reusable Model

Flat Size Baskets

Wire Basket

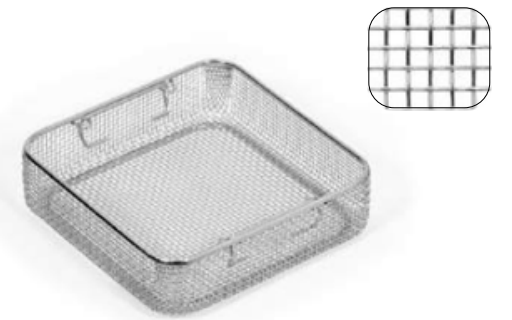

Perforated Basket

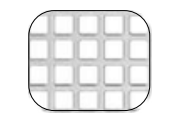
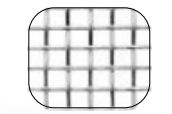
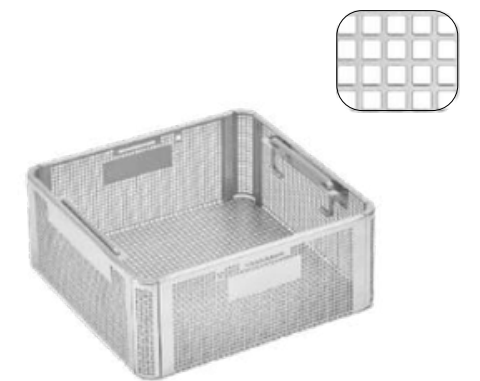

Reusable Model

Mini Size

 Different Lids Colors



With Reusable Mechanism



With Color Options



Non Perforated

Code	Outside Dimension Inside Dimension L x W x H
K1-70-70	315 x 130 x 70 mm 275 x 127 x 60 mm
K1-70-100	315 x 130 x 100 mm 275 x 127 x 90 mm
K1-70-130	315 x 130 x 130 mm 275 x 127 x 120 mm

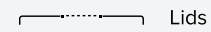

Lids

Colors	Code
Grey	K3-70-1
Yellow	K3-70-2
Green	K3-70-3
Blue	K3-70-4
Red	K3-70-5
Black	K3-70-6
Purple	K3-70-7
Bronze	K3-70-8

Dimension
315 x 130 mm

Wire Basket



Mesh: 4x4 mm
Wire: ø 1 mm



Box

Code	Outside Dimension L x W x H
B1-2712-40	270 x 117 x 40 mm
B1-2712-100	268 x 117 x 100 mm

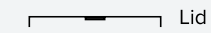

Lid

Code	Outside Dimension L x W x H
B1-2712	270 x 117 x 5 mm

Perforated Basket



Mesh: 4x4 mm
Wire: ø 1 mm



Box (with 10 mm feet)

Code	Outside Dimension L x W x H
B2-2712-40	265 x 125 x 50 mm
B2-2712-100	265 x 125 x 110 mm

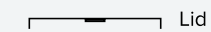

Lid

Code	Outside Dimension L x W x H
B2-2712	268 x 128 x 5 mm

Silicone Mat



Code	Outside Dimension L x W x H
A7-2712	270 x 125 mm

Reusable Model

Mini Size Baskets

Wire Basket



Perforated Basket

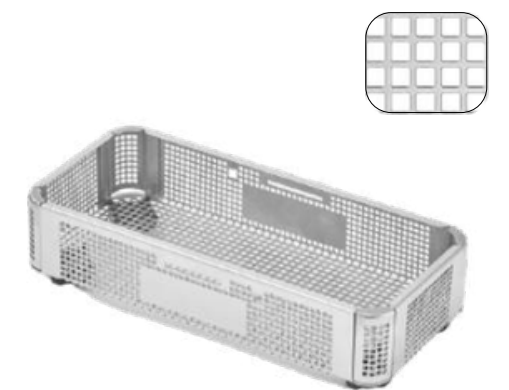

Reusable Model

Dental Size

 Different Lids Colors



With Reusable Mechanism



With Color Options



Non Perforated

Code	Outside Dimension Inside Dimension L x W x H
K1-60-70	320 x 185 x 70 mm 280 x 182 x 40 mm
K1-60-100	320 x 185 x 100 mm 280 x 182 x 90 mm
K1-60-130	320 x 185 x 130 mm 280 x 182 x 120 mm

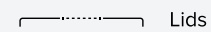

Lids

Colors	Code
Grey	K3-60-1
Yellow	K3-60-2
Green	K3-60-3
Blue	K3-60-4
Red	K3-60-5
Black	K3-60-6
Purple	K3-60-7
Bronze	K3-60-8

Dimension
320 x 190 mm

Wire Basket



Mesh: ø 4x4 mm
Wire: ø 1 mm

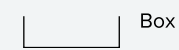

Box

Code	Outside Dimension L x W x H
B1-2717-40	270 x 170 x 40 mm
B1-2717-100	270 x 170 x 100 mm



Lid

Code	Outside Dimension L x W x H
B1-2717	270 x 170 x 5 mm

Perforated Basket



Mesh: ø 4x4 mm
Wire: ø 1 mm

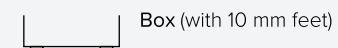

Box (with 10 mm feet)

Code	Outside Dimension L x W x H
B2-2717-40	275 x 175 x 50 mm
B2-2717-100	275 x 175 x 110 mm



Lid

Code	Outside Dimension L x W x H
B2-2717	278 x 178 x 5 mm

Reusable Model

Dental Size Baskets

Wire Basket

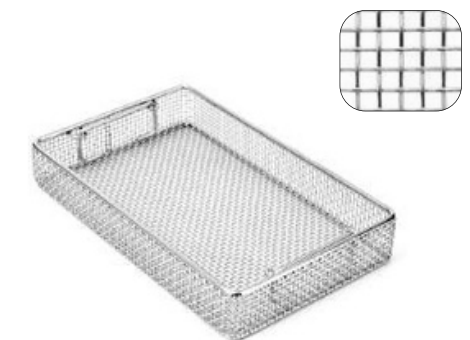

Perforated Basket



Reusable Model

1/2DentalSize

Different Lids Colors



With Reusable Mechanism



With Color Options



Code	Outside Dimension Inside Dimension L x W x H
K1-80-70	225 x 160 x 70 mm 190 x 157 x 60 mm
K1-80-100	225 x 160 x 100 mm 190 x 157 x 90 mm
K1-80-130	225 x 160 x 130 mm 190 x 157 x 120 mm

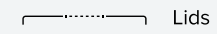

Colors	Code
Grey	K3-80-1
Yellow	K3-80-2
Green	K3-80-3
Blue	K3-80-4
Red	K3-80-5
Black	K3-80-6
Purple	K3-80-7
Bronze	K3-80-8

Dimension
230 x 175 mm

Wire Basket



Mesh: ø 4x4 mm
Wire: ø 1 mm



Code	Outside Dimension L x W x H
B1-1714-40	175 x 145 x 40 mm
B1-1714-100	175 x 145 x 100 mm

Code	Outside Dimension L x W x H
B1-1714	175 x 145 x 5 mm

Reusable Model

1/2 Dental Size Baskets

Wire Basket



Perforated Basket



Perforated Basket



Mesh: ø 4x4 mm
Wire: ø 1 mm



Code	Outside Dimension L x W x H
B2-1714-40	175 x 145 x 50 mm
B2-1714-100	175 x 145 x 110 mm

Code	Outside Dimension L x W x H
B2-1714	178 x 148 x 5 mm

Organize.
Sterilize.

Excel.

Holding the
Standard

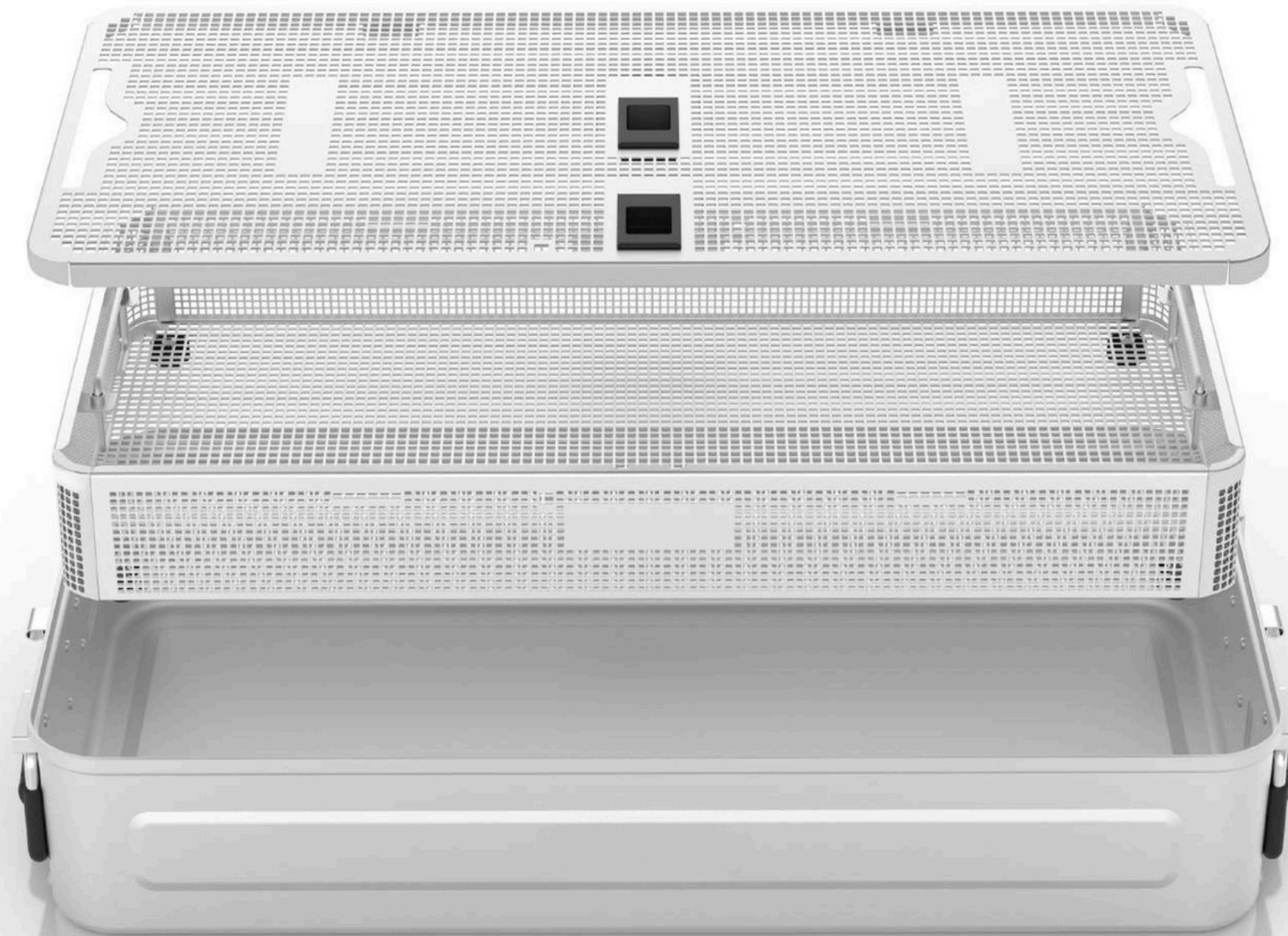

Three Different Types of Basket Models by Construction/Material



Perforated Sheet
Ø 1 mm
□ 4 mm

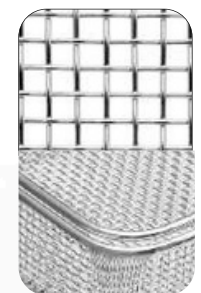

Wire Mesh
Ø 1 mm
□ 4 mm

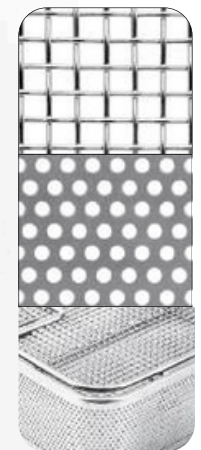

Hybrith
Ø 1 mm
□ 4 mm
Side Mesh
Ø 3 mm

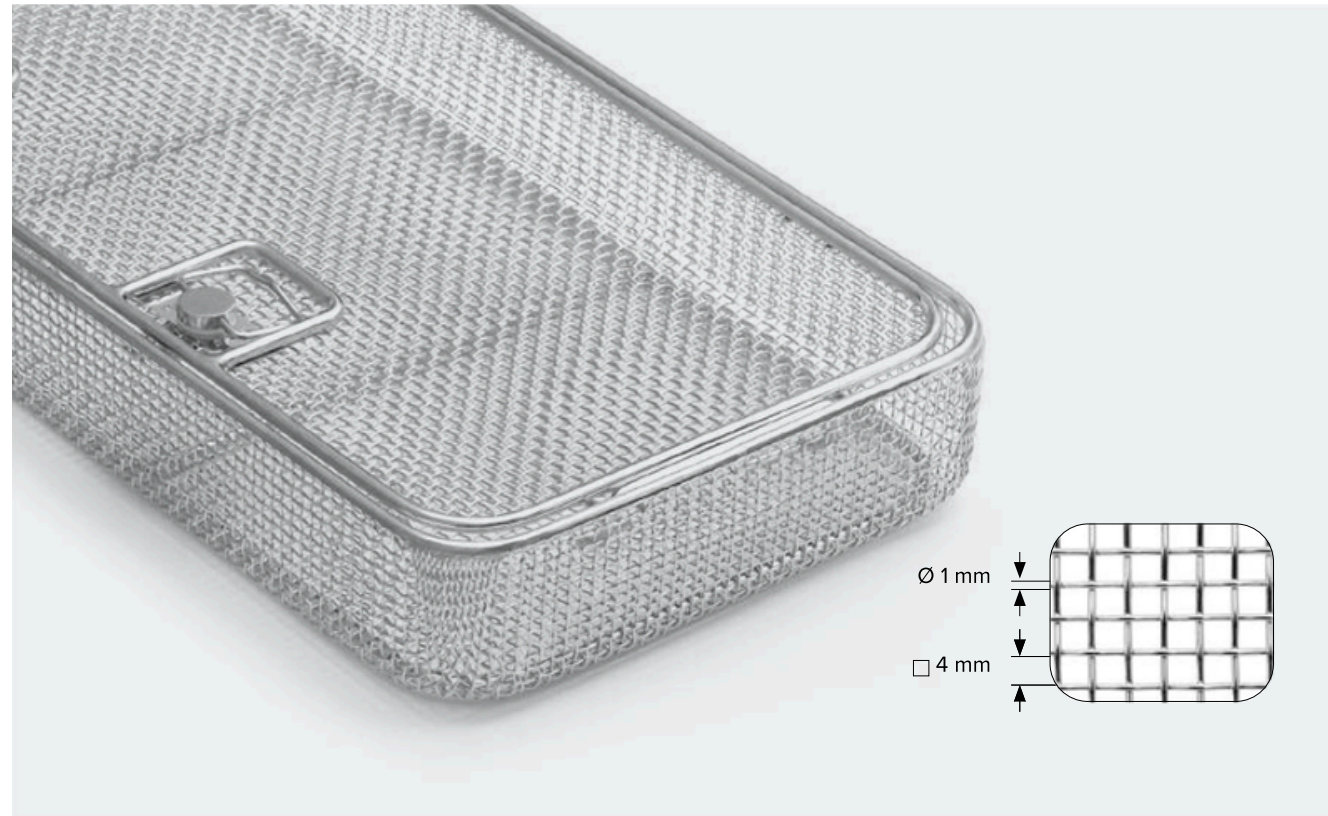

Half Size

Box Code	Outside Dimension L x W x H
B1-2525-30	255 x 245 x 30 mm
B1-2525-50	255 x 245 x 50 mm
B1-2525-70	255 x 245 x 70 mm
B1-2525-100	255 x 245 x 100 mm

Lid Code	Outside Dimension L x W x H
B1-2525	240 x 215 x 5 mm

Long Size

Box Code	Outside Dimension L x W x H
B1-6625-50	665 x 250 x 50 mm
B1-6625-70	665 x 250 x 70 mm
B1-6625-100	665 x 250 x 100 mm
-	-

Lid Code	Outside Dimension L x W x H
B1-6625	635 x 235 x 5 mm

Wide Size

Box Code	Outside Dimension L x W x H
B1-5333-50	533 x 337 x 50 mm
B1-5333-70	533 x 337 x 70 mm
B1-5333-100	533 x 337 x 100 mm
-	-

Lid Code	Outside Dimension L x W x H
B1-5333	533 x 337 x 5 mm

Full Size

Box Code	Outside Dimension L x W x H
B1-5425-30	540 x 255 x 30 mm
B1-5425-50	540 x 255 x 50 mm
B1-5425-70	540 x 255 x 70 mm
B1-5425-100	540 x 255 x 100 mm

Lid Code	Outside Dimension L x W x H
B1-5425	510 x 240 x 5 mm

Din Size

Box Code	Outside Dimension L x W x H
B1-4825-30	485 x 255 x 30 mm
B1-4825-50	485 x 255 x 50 mm
B1-4825-70	485 x 255 x 70 mm
B1-4825-100	485 x 255 x 100 mm

Lid Code	Outside Dimension L x W x H
B1-4825	455 x 240 x 5 mm

Quarter Size

Box Code	Outside Dimension L x W x H
B1-4025-30	405 x 255 x 30 mm
B1-4025-50	405 x 255 x 50 mm
B1-4025-70	405 x 255 x 70 mm
B1-4025-100	405 x 255 x 100 mm

Lid Code	Outside Dimension L x W x H
B1-4025	375 x 240 x 5 mm

Dental Size

Box Code	Outside Dimension L x W x H
B1-2717-40	270 x 170 x 40 mm
B1-2717-100	270 x 170 x 100 mm
-	-
-	-

Lid Code	Outside Dimension L x W x H
B1-2717	270 x 170 x 5 mm

Mini Size

Box Code	Outside Dimension L x W x H
B1-2712-40	270 x 117 x 40 mm
B1-2712-100	270 x 117 x 100 mm
-	-
-	-

Lid Code	Outside Dimension L x W x H
B1-2712	270 x 117 x 5 mm

Dental 1/2

Box Code	Outside Dimension L x W x H
B1-1714-40	175 x 145 x 40 mm
B1-1714-100	175 x 145 x 100 mm
-	-
-	-

Lid Code	Outside Dimension L x W x H
B1-1714	175 x 145 x 5 mm

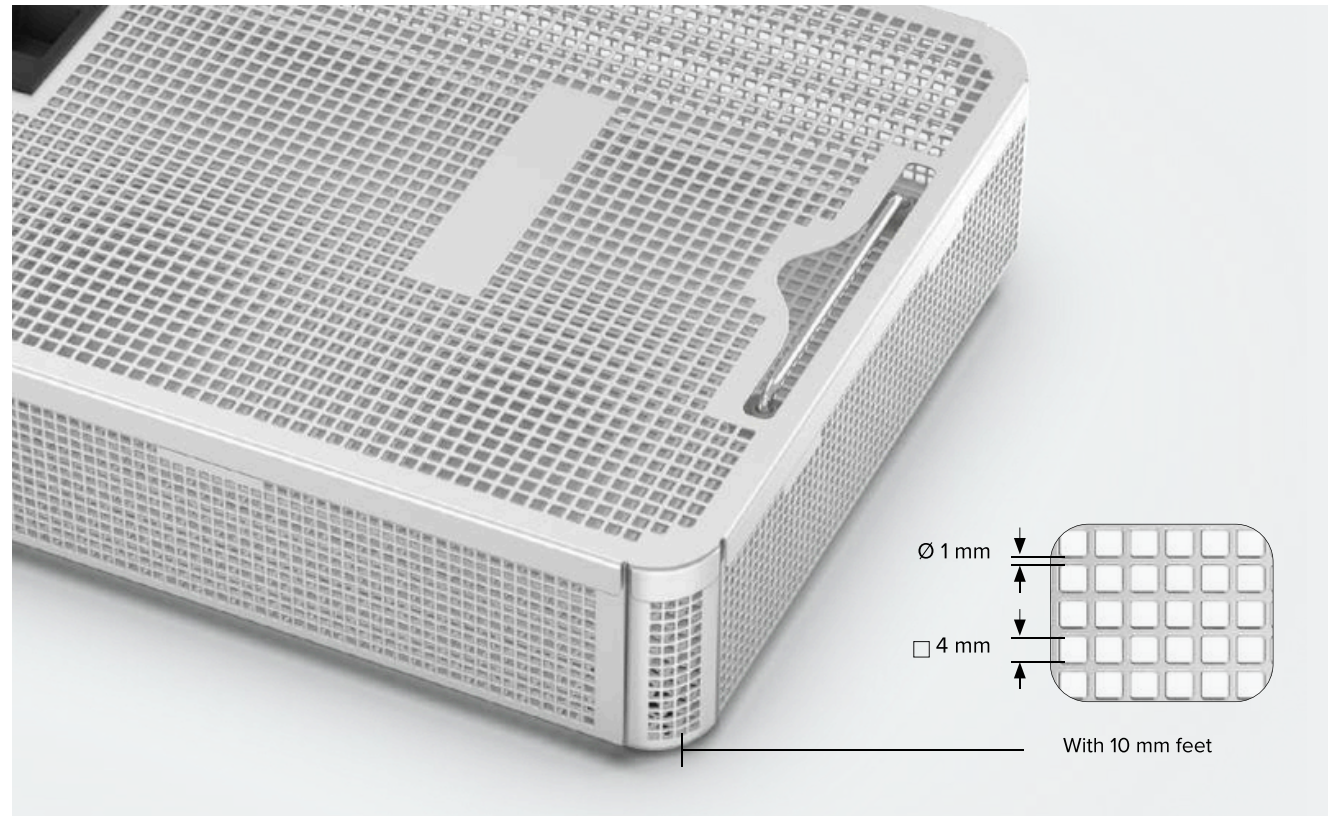

Half Size



Box Code	Outside Dimension L x W x H
B2-2525-30	242 x 252 x 40 mm
B2-2525-50	242 x 252 x 60 mm
B2-2525-70	242 x 252 x 80 mm
B2-2525-100	242 x 252 x 110 mm

Lid Code	Outside Dimension L x W x H
B2-2525	246 x 256 x 5 mm

Long Size



Box Code	Outside Dimension L x W x H
B2-6625-30	665 x 253 x 40 mm
B2-6625-50	665 x 253 x 60 mm
B2-6625-70	665 x 253 x 80 mm
B2-6625-100	665 x 253 x 110 mm

Lid Code	Outside Dimension L x W x H
B2-6625	668 x 256 x 5 mm

Wide Size



Box Code	Outside Dimension L x W x H
B2-5333-30	533 x 339 x 40 mm
B2-5333-50	533 x 339 x 60 mm
B2-5333-70	533 x 339 x 80 mm
B2-5333-100	533 x 339 x 110 mm

Lid Code	Outside Dimension L x W x H
B2-5333	536 x 343 x 5 mm

Full Size



Box Code	Outside Dimension L x W x H
B2-5425-30	540 x 255 x 40 mm
B2-5425-50	540 x 255 x 60 mm
B2-5425-70	540 x 255 x 80 mm
B2-5425-100	540 x 255 x 110 mm

Lid Code	Outside Dimension L x W x H
B2-5425	543 x 256 x 5 mm

Din Size



Box Code	Outside Dimension L x W x H
B2-4825-30	484 x 252 x 40 mm
B2-4825-50	484 x 252 x 60 mm
B2-4825-70	484 x 252 x 80 mm
B2-4825-100	484 x 252 x 110 mm

Lid Code	Outside Dimension L x W x H
B2-4825	488 x 256 x 5 mm

Quarter Size



Box Code	Outside Dimension L x W x H
B2-4025-30	405 x 252 x 40 mm
B2-4025-50	405 x 252 x 60 mm
B2-4025-70	405 x 252 x 80 mm
B2-4025-100	405 x 252 x 110 mm

Lid Code	Outside Dimension L x W x H
B2-4025	409 x 256 x 5 mm

Dental Size



Box Code	Outside Dimension L x W x H
B2-2717-40	275 x 175 x 50 mm
B2-2717-100	275 x 175 x 110 mm
-	-
-	-

Lid Code	Outside Dimension L x W x H
B2-2717	278 x 178 x 5 mm

Mini Size



Box Code	Outside Dimension L x W x H
B2-2712-40	265 x 125 x 50 mm
B2-2712-100	265 x 125 x 50 mm
-	-
-	-

Lid Code	Outside Dimension L x W x H
B2-2712	268 x 128 x 5 mm

Dental 1/2



Box Code	Outside Dimension L x W x H
B2-1714-40	175 x 145 x 50 mm
B2-1714-100	175 x 145 x 110 mm
-	-
-	-

Lid Code	Outside Dimension L x W x H
B2-1714	178 x 148 x 5 mm

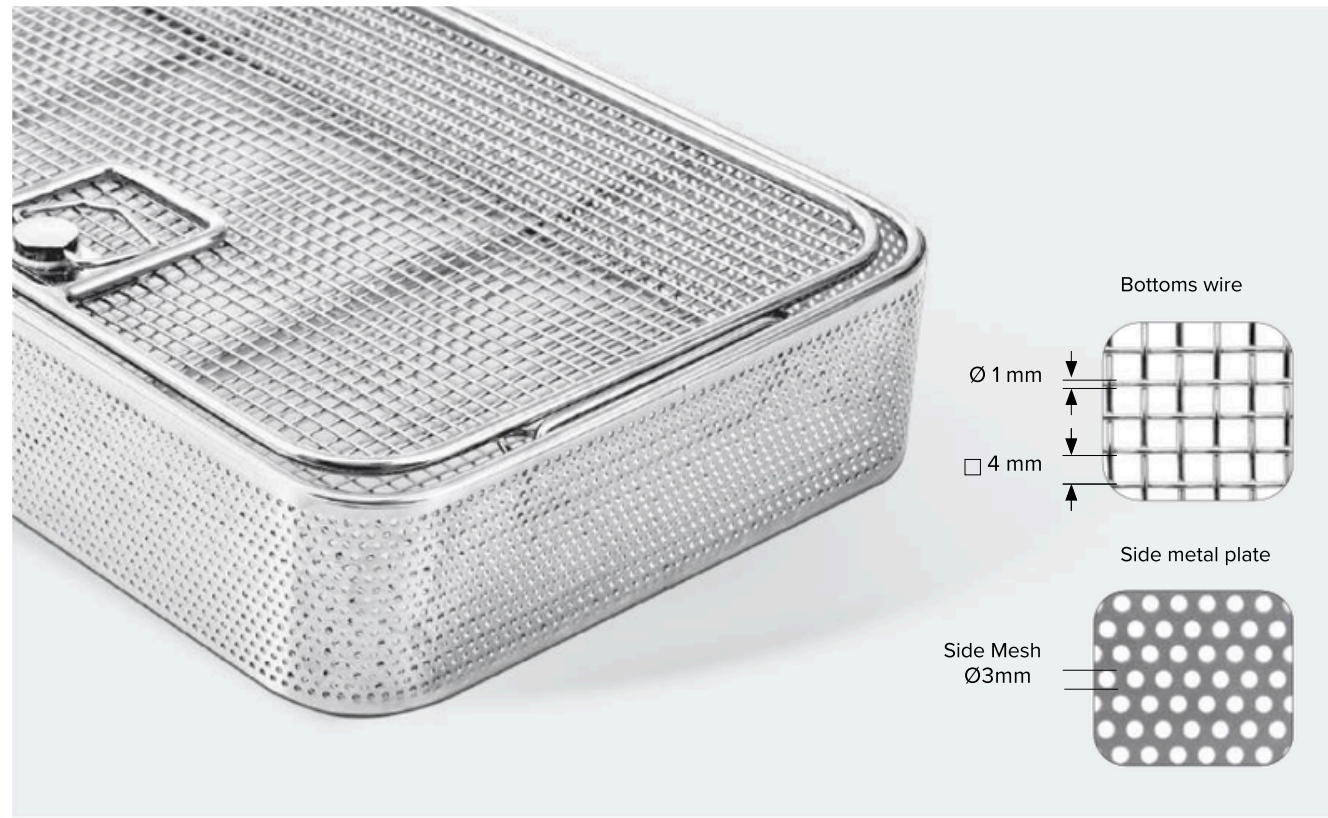

Half Size

Box Code	Outside Dimension L x W x H
B3-2525-50	245 x 245 x 50 mm
B3-2525-70	245 x 245 x 70 mm
B3-2525-100	245 x 245 x 100 mm

Lid Code	Outside Dimension L x W x H
B1-2525	245 x 245 x 5 mm

Long Size

Box Code	Outside Dimension L x W x H
B3-6625-50	665 x 245 x 50 mm
B3-6625-70	665 x 245 x 70 mm
B3-6625-100	665 x 245 x 100 mm

Lid Code	Outside Dimension L x W x H
B1-6625	665 x 245 x 5 mm

Wide Size

Box Code	Outside Dimension L x W x H
B3-5333-50	533 x 337 x 50 mm
B3-5333-70	533 x 337 x 70 mm
B3-5333-100	533 x 337 x 100 mm

Lid Code	Outside Dimension L x W x H
B1-5333	533 x 337 x 5 mm

Fine Mesh Baskets

Full Size

Box Code	Outside Dimension L x W x H
B3-5425-50	540 x 255 x 50 mm
B3-5425-70	540 x 255 x 70 mm
B3-5425-100	540 x 255 x 100 mm

Lid Code	Outside Dimension L x W x H
B1-5425	540 x 245 x 5 mm

Din Size

Box Code	Outside Dimension L x W x H
B3-4825-50	484 x 252 x 40 mm
B3-4825-70	484 x 252 x 70 mm
B3-4825-100	484 x 252 x 100 mm

Lid Code	Outside Dimension L x W x H
B1-4825	485 x 245 x 5 mm

Quarter Size

Box Code	Outside Dimension L x W x H
B3-4025-50	405 x 252 x 45 mm
B3-4025-70	405 x 252 x 70 mm
B3-4025-100	405 x 252 x 100 mm

Lid Code	Outside Dimension L x W x H
B1-4025	405 x 245 x 5 mm

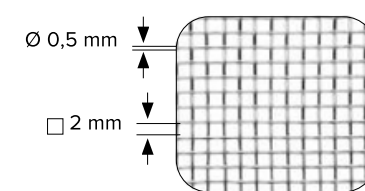
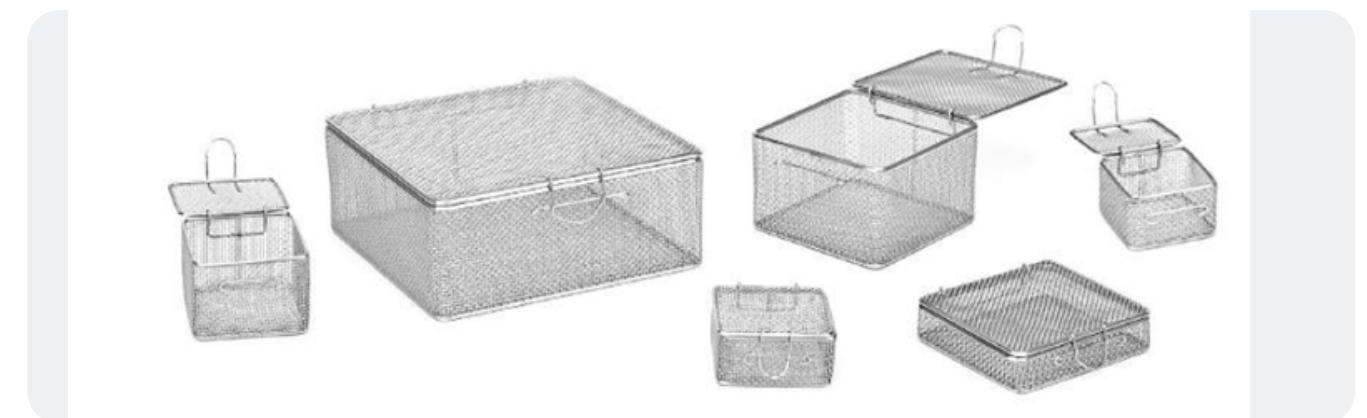

Box Code	Outside Dimension L x W x H
B4-33-30	30 x 30 x 30 mm
B4-44-20	40 x 40 x 20 mm
B4-66-20	60 x 60 x 20 mm
B4-66-40	60 x 60 x 40 mm
B4-84-40	80 x 40 x 40 mm

Box Code	Outside Dimension L x W x H
B4-88-40	80 x 80 x 40 mm
B4-88-60	80 x 80 x 60 mm
B4-1212-30	120 x 120 x 30 mm
B4-1212-60	120 x 120 x 60 mm
B4-2424-60	240 x 240 x 60 mm

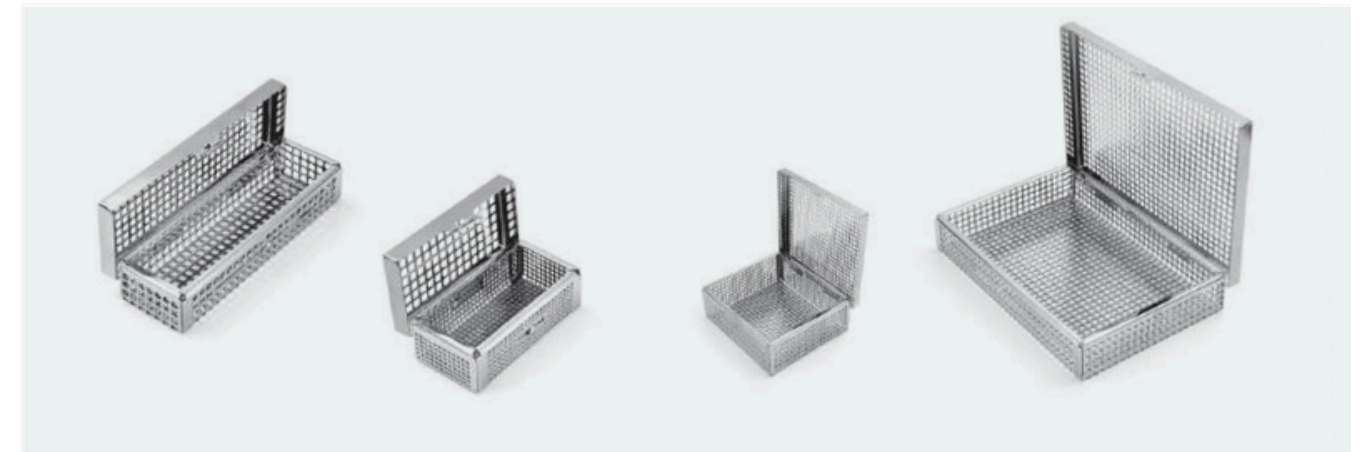

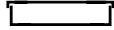
 Bottom With Lid
W/O Feet
Wire: \varnothing 1 mm
Mesh: 4x4 mm

Code	Dimension L x W x H	Code	Dimension L x W x H
B2-2718-32	275 x 180 x 32 mm	B2-188-32	188 x 86 x 32 mm
B2-2718-42	275 x 180 x 42 mm	B2-144-28	146 x 46 x 28 mm
B2-247-30	240 x 76 x 30 mm	B2-84-28	86 x 46 x 28 mm
B2-1913-34	190 x 130 x 34 mm		

STU - SPRI Baskets

Wire Basket
Single Scope

Code
B5-298-55-S

Dimension
L x W x H
290 x 80 x 55 mm

Code
B5-468-55-S

Dimension
L x W x H
460 x 80 x 55 mm

Wire Basket
Double Scope

Code
B5-298-55-D

Dimension
L x W x H
290 x 80 x 55 mm

Code
B5-468-55-D

Dimension
L x W x H
460 x 80 x 55 mm

Perforated Basket
Single Scope

Code
B5-278-44-S

Dimension
L x W x H
290 x 80 x 55 mm

Code
B5-458-44-S

Dimension
L x W x H
452 x 83 x 44 mm

Perforated Basket
Double Scope

Code
B5-2710-44-D

Dimension
L x W x H
290 x 80 x 55 mm

Code
B5-4510-44-D

Dimension
L x W x H
452 x 83 x 44 mm



STU Baskets

Box Code	Outside Dimension L x W x H	Details
B7-5728-135	575 x 280 x 135 mm	Upper Frame: \varnothing 6 mm
B7-5728-265	575 x 280 x 265 mm	Body Wires: \varnothing 2 & 3 mm Base Frame \varnothing 5 mm

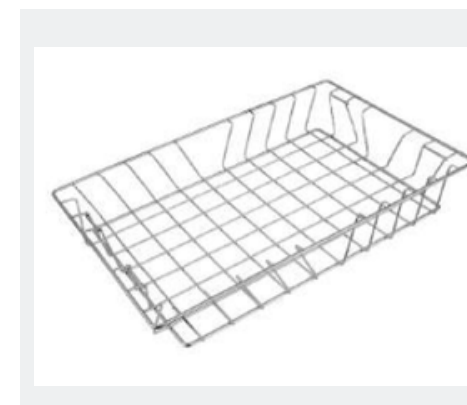

SPRI Baskets

Box Code	Outside Dimension L x W x H	Details
B8-6030-40	600x300x40 mm	Main Frame: \varnothing 6 mm
B8-6030-100	600x300x100 mm	Body Wire: \varnothing 4 mm
B8-6030-150	600x300x150 mm	Base Frame \varnothing 5 mm
B8-6040-100	600x400x100 mm	Single Frame Stackable
B8-6040-150	600x400x150 mm	
B8-6040-200	600x400x200 mm	



Paper Filters	
Code A1-10-1 For: 1/1, 3/4, 1/2, Long, Wide Size: ø 185 mm	Code A1-11-1 For: Small Size Containers Size: ø 88 mm
Material 73g/m ² Medical Grade Paper	Package 100 pcs
Sterilization Steam	Cycle Single Use

PTFE Teflon Filters	
Code A1-20-1 For: 1/1, 3/4, 1/2, Long, Wide Size: ø 185 mm	Code A1-21-1 For: Small Size Containers Size: ø 88 mm
Material 1 mm (± 0,25) PTFE	Package 1 Piece
Sterilization Steam & EtO	Cycle 2000 Cycle Reusable

Polymer Security Seals	
Code A2-10-1 Package 100 pcs Sterilization Steam Cycle Single Use Color Blue	Code A2-20-1 Package 100 pcs Sterilization Steam Cycle Single Use Color Red

Polymer Security Seals With Indicator	
Code A2-10-2 Package 100 pcs Sterilization Steam Cycle Single Use Color Blue	Code A2-20-2 Package 100 pcs Sterilization Steam Cycle Single Use Color Red

Identification Labels			
Color	Code	Color	Code
	A5-10-1		A5-10-5
	A5-10-2		A5-10-6
	A5-10-3		A5-10-7
	A5-10-4		A5-10-8
Material	1,5 mm Aluminum	Package	16 x 25 mm
			1 Piece
Sterilization	Steam	Marking	Maximum 24 Letters

Paper Labels	
Code A3-10-1 with indicator	Code A3-10-2 with indicator
Material Paper	Size Big & Small
Package 100 pcs	Sterilization Steam

Filter Retainers	
Code A6-10-1 For: 1/1, 3/4, 1/2, Long, Wide	Code A6-10-2 For: Small Size Containers
Material Stainless Steel	Package 1 piece

Silicone Mats & Nets			
	Code A7-5425 A7-4025 A7-2525 A7-2712	Size 500 X 235 mm 370 X 235 mm 225 x 235 mm 270 x 125 mm	
			Code A4-5425 A4-4025 A4-2525
			Size 520 x 242 mm 380 x 242 mm 255 x 250 mm
	h: 14 mm h: 5 mm h: 2 mm	h: 16 mm	Material Medical Grade Silicone Package 1 Piece Sterilization Steam Color Light Blue

Silicone Gasket					
	Code A11-10-1 A11-20-1 A11-30-1	Size 1/1 Full 3/4 Quarter 1/2 Half	Code A11-40-1 A11-50-1 A11-60-1	Size Long Wide Dental	Code A11-70-1 A11-80-1 A11-90-1
					Size Mini 1/2 Dental Flat
					Material Medical Grade Sealing Silicone Package 1 Piece Shape D shape, Jointless Feature Place & Go, No Glue Required



Code T1-10-1
 Material : Stainless Steel
 Feet : 4 wheels - 2 braked
 Package : 1 Piece
 Dimensions: 600 x 860 x 900 mm (W x L x H)



Code T1-10-2
 Material : Stainless Steel
 Feet : 4 wheels - 2 braked
 Package : 1 Piece
 Dimensions: 550 x 860 x 900 mm (W x L x H)



Code T1-10-5
 Material : Stainless Steel
 Feet : 4 Adjustable Leveling Feet
 Package : 1 Piece
 Dimensions: 600 x 1400 x 850 mm (W x L x H)



Code T1-10-6
 Material : Stainless Steel
 Feet : 4 wheels - 2 braked
 Package : 1 Piece
 Dimensions: 700 x 360 x 1350 mm (W x L x H)



Code T1-10-3
 Material : Stainless Steel
 Feet : 4 wheels - 2 braked
 Package : 1 Piece
 Dimensions: 600 x 850 x 900 mm (W x L x H)



Code T1-10-4
 Material : Stainless Steel
 Feet : 4 wheels - 2 braked
 Package : 1 Piece
 Dimensions: 550 x 860 x 900 mm (W x L x H)

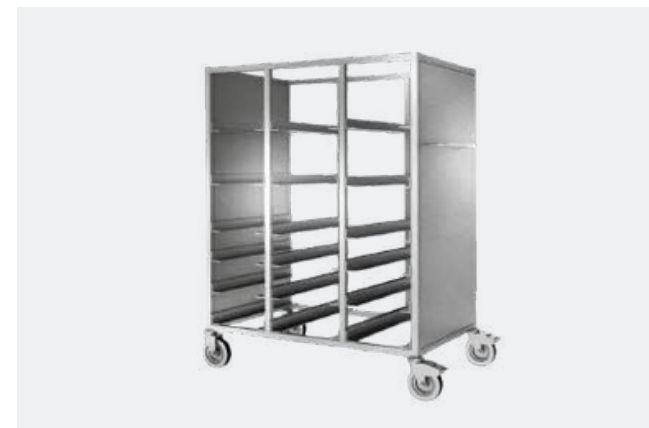

Code T1-10-7
 Material : Stainless Steel
 Feet : 4 wheels - 2 braked
 Package : 1 Piece
 Dimensions: 700 x 360 x 1350 mm (W x L x H)



Code T1-10-8
 Material : Stainless Steel
 Feet : 4 wheels - 2 braked
 Package : 1 Piece - including 3 baskets
 Dimensions: 400 x 600 x 1700 (W x L x H)